

R&S® SMBV100A

Vector Signal Generator

Generating signals for today and tomorrow



75 Years of
Driving
Innovation



R&S®SMBV100A Vector Signal Generator At a glance

A state-of-the-art vector signal generator must be flexible and offer good signal characteristics along with an outstanding cost/benefit ratio. In all of these areas, the R&S®SMBV100A sets new standards in the mid-range class of instruments.

- Internal signal generation for all major digital radio standards with optional integrated baseband source
- Highest output level in its class up to 6 GHz, combined with excellent RF characteristics
- Lowest cost of ownership due to outstanding price/performance ratio and on-site service capabilities
- Ideal adaptation to customer applications

The R&S®SMBV100A offers excellent RF performance along with very high output level and short setting times. At the same time, the R&S®SMBV100A can be equipped with an internal baseband generator to allow generation of a number of digital standards (e.g. WiMAX, HSPA+, LTE). The wide frequency range from 9 kHz to 6 GHz covers all of the important bands for digital modulation.

Due to its optimal scalability, the R&S®SMBV100A is easy to customize to meet specific customer requirements. For production applications, a cost-effective solution for playing back predefined test sequences is available with the optional baseband arbitrary waveform generator (ARB). And where it really matters, the optional baseband coder provides impressive realtime capabilities. It allows the generation of even complex signals directly in the instrument – no external signal generation software is required.

The R&S®SMBV100A has also been designed for ease of servicing. Together with its scalability, this helps to ensure very low cost of ownership. The instrument's compact size and graphical user interface for intuitive operation help to fulfill all possible requirements.

These features make the R&S®SMBV100A ideal in development applications as well as in production and service. This instrument truly does the job wherever signals with digital modulation are needed.



R&S®SMBV100A

Vector Signal Generator

Benefits and key features

Ready for future applications today

- ▮ Future-proof hardware concept
- ▮ RF section with high output level up to 6 GHz
- ▮ Wide RF signal bandwidth of up to 120 MHz with internal signal generation
- ▮ Maximum RF bandwidth of I/Q modulator exceeds 500 MHz
- ▮ Always up-to-date with software upgrades

▷ [Page 4](#)

Customized internal signal generation with optional baseband generator

- ▮ Baseband coder with realtime capabilities for direct signal generation
- ▮ Integrated ARB for playback of precalculated waveforms
- ▮ Availability of ARB-only versions with different bandwidths
- ▮ Memory depth of up to 256 Msamples for long test sequences

▷ [Page 6](#)

Support for all important state-of-the-art digital standards

- ▮ Straightforward signal configuration due to easy-to-use GUI
- ▮ 2G/3G/LTE mobile radio standards
- ▮ Wireless standards including mobile WiMAX and WLAN IEEE 802.11n

▷ [Page 8](#)

High-performance RF for all types of applications

- ▮ Excellent phase noise ensures low EVM with digital signals
- ▮ High output level compensates for losses in test/system setup
- ▮ Fast settling time for quicker measurements
- ▮ Analog modulation for basic measurements

▷ [Page 10](#)

Flexible signal processing and baseband connectivity

- ▮ CW interference and AWGN simulation
- ▮ Analog and digital baseband outputs
- ▮ Support for R&S®EX-IQ-Box digital interface adapter

▷ [Page 12](#)

Low cost of ownership due to simple service concept

- ▮ Fast on-site servicing
- ▮ Long calibration interval (three years) minimizes service costs
- ▮ Straightforward modular design for short repair times

▷ [Page 13](#)

Allrounder and specialist at the same time

- ▮ Optimized for high production throughput
 - Multisegment waveform mode for fast switchover between test sequences
 - High level repeatability ensures stable test conditions
- ▮ Prepared for aerospace and defense applications
 - Versatile capabilities for generating unmodulated as well as complex modulated pulses
 - Coupling of multiple instruments for phase-coherent RF generation

▷ [Page 14](#)

Ready for future applications today

With constantly rising cost pressures, investments made today must also be able to meet future requirements. The R&S®SMBV100A was developed to satisfy this objective and is setting new standards for this class of instrument.

Key features

Frequency range	9 kHz to 3.2 GHz or 6 GHz
Level range	typ. -120 dBm to +24 dBm
Customized instrument configuration	
Internal signal generation for various standards (optional)	
Internal bandwidth	up to 120 MHz in RF range
External bandwidth	>500 MHz in RF range – suitable for UWB

Future-proof hardware concept

The R&S®SMBV100A vector signal generator benefits from a carefully planned instrument concept. Depending on the configuration, the instrument can function as a pure I/Q upconverter, a cost-effective signal generator with integrated ARB or an advanced vector signal generator with internal signal generation and realtime capabilities. The instrument concept allows the signal generator to be adapted to the individual task at hand, thereby reducing the investment required. At the same time, the performance of the individual hardware components provides ample capacity for future applications as well.

RF section with high output level up to 6 GHz

The R&S®SMBV100A is available with options for a maximum frequency of 3.2 GHz or 6 GHz, covering all major frequency bands for wireless communications and other radio applications.

The standard electronic attenuator with integrated over-voltage protection ensures dependable operation of the R&S®SMBV100A – even in challenging production environments. The maximum output level is typ. +24 dBm over the entire frequency range above 1 MHz.

Instrument overview

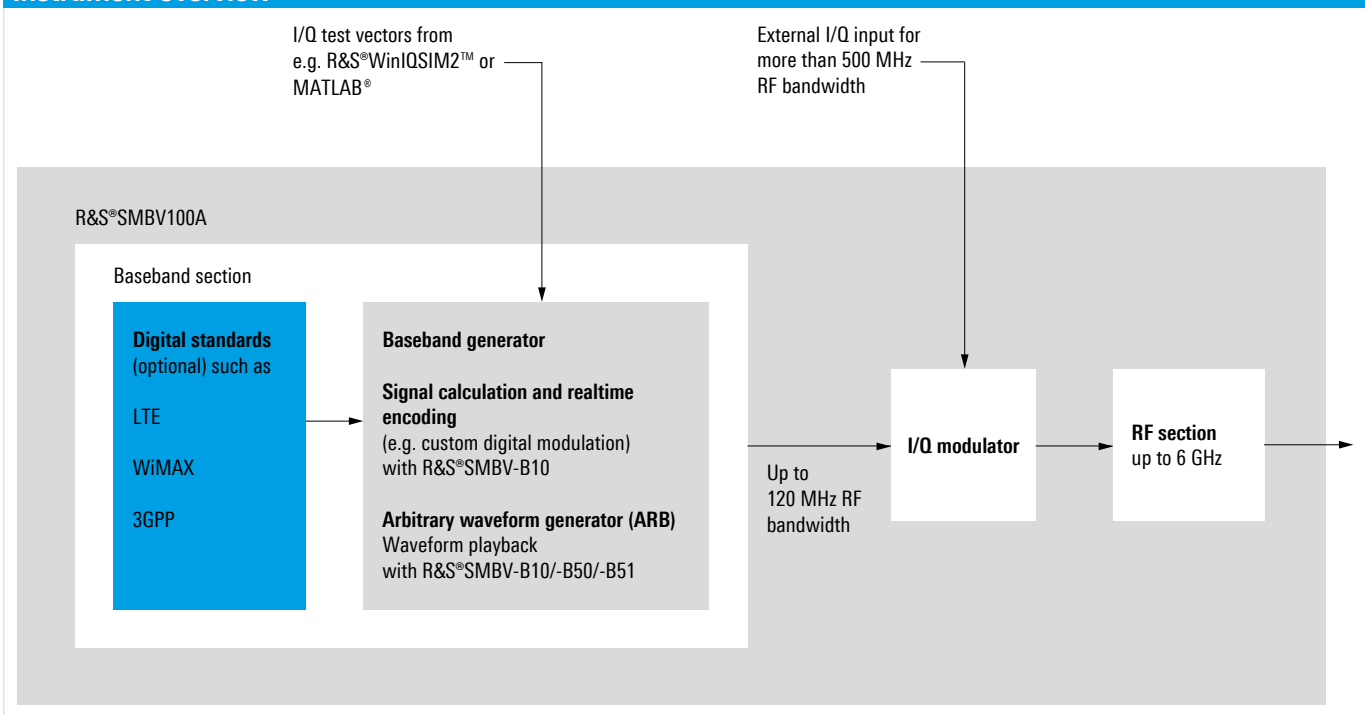

Wide RF signal bandwidth of up to 120 MHz with internal signal generation

The wide R&S®SMBV100A RF bandwidth extending up to 120 MHz with internal signal generation is more than adequate for the latest broadband digital standards such as LTE and WiMAX. This bandwidth also offers ample capacity for future standards. Since it is easy to import test signals you create on your own, e.g. with MATLAB®, the R&S®SMBV100A is well prepared to generate the signals you will also need in the future.

Frequency response of the I/Q modulator with bandwidth of over 500 MHz

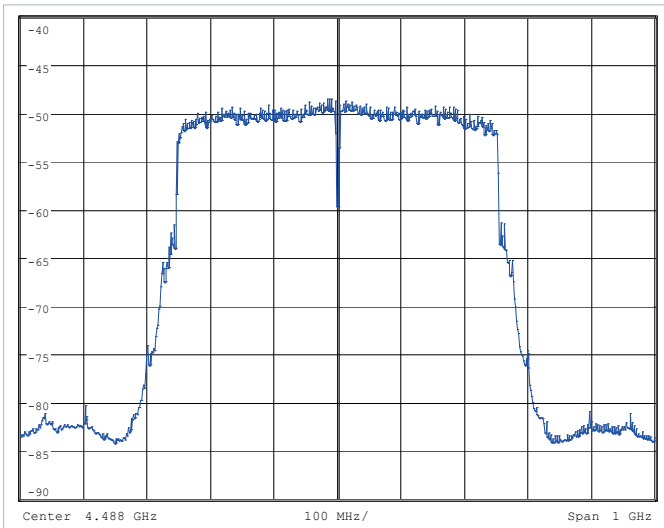

Maximum RF bandwidth of I/Q modulator exceeds 500 MHz

The integrated I/Q modulator provides a maximum RF bandwidth of over 500 MHz for externally supplied I/Q signals. For example, this wide bandwidth allows upconversion of UWB signals, which can be generated as I/Q signals by the R&S®AFQ100B baseband signal generator. This wide bandwidth is also available for use with frequency agility or steep-edged pulse modulation with a flexible external I/Q source such as the R&S®AFQ100B.

Always up-to-date with software upgrades

The powerful baseband generator is already prepared to handle future applications. The flexible software architecture allows the integration of new standards and extension of existing standards based on simple software updates, requiring no investment in new hardware.

R&S®SMBV100A and R&S®AFQ100B



Customized internal signal generation with optional baseband generator

Key features

Internal signal generation (optional)
Choice of three different baseband generators (internal signal generation with realtime capabilities or two ARB-only versions)
ARB with 32 Msamples, extendable up to 256 Msamples
ARB supported by R&S®WinIQSIM2™
Easy interaction with MATLAB®
Optional 80 Gbyte mass memory for storage of signals

The one aspect that truly makes the R&S®SMBV100A stand out is its optional baseband generator, which is available in three different versions for different applications:

Version	Option	Baseband generator	RF bandwidth
1	R&S®SMBV-B10	Baseband coder with realtime capabilities and ARB (32 Msample or 256 Msample)	120 MHz
2	R&S®SMBV-B50	ARB only (32 Msample or 256 Msample)	120 MHz
3	R&S®SMBV-B51	ARB only (32 Msample or 256 Msample)	60 MHz

Baseband coder with realtime capabilities for direct signal generation

The most powerful baseband generator (R&S®SMBV-B10) includes an integrated arbitrary waveform generator as well as a baseband coder that allows signal generation directly in the instrument. Besides realtime generation of signals for user-configurable digital modulation, a multitude of digital standards such as HSPA+, LTE, WLAN and WiMAX are also supported (option). All signal parameters are configured directly on the instrument. Even complex signals can be generated with only a few keystrokes. Multicarrier test scenarios can also be defined on the instrument itself no matter whether working with different or the same digital standards. Multicarrier power amplifier (MCPA) tests and interoperability tests are very easy to perform.

The R&S®SMBV-B10 baseband generator thus totally eliminates the need to generate test signals using an external computer and transfer them to the vector signal generator. This is especially beneficial in a development environment where fast, easy access to signal parameters is critical during both manual operation and remote operation. This helps to speed up the work flow and minimize development time.

The realtime coder also enables the user to generate test sequences with a theoretically infinite length, e.g. with simple digitally modulated signals or internally generated digital standards such as 3GPP FDD (downlink) and GSM. This makes bit error rate tests reliable in cases where a sufficiently long test sequence is needed for statistical assessment.

Integrated ARB for playback of precalculated waveforms

Precalculated test sequences are common especially in production environments. The R&S®SMBV100A is also well equipped in this area: All three versions of the baseband generator are capable of playing back precalculated waveforms. When it comes to generating standard-compliant signals, the external R&S®WinIQSIM2™ waveform generation software is also available. It supports standards such as LTE, HSPA+ and WiMAX. Proprietary signals and special test vectors (e.g. generated using MATLAB®) can also be played back from the integrated ARB with no problem. The two ARB-only versions (R&S®SMBV-B50/-B51) are recommended in all instances where a cost-saving solution is needed and there is no need to set signal parameters directly on the instrument.

Memory depth of up to 256 Msamples for long test sequences

The ARB memory can be extended from the standard size of 32 Msamples to 256 Msamples. This makes it possible to play back long test sequences for realistic measurements on DUTs.

If the optional mass memory (R&S®SMBV-B92) is installed in the R&S®SMBV100A, it is easy to save test sequences in the instrument and recall them for later use without having to retransfer them. This speeds up manual tests and is of course also useful in production applications where numerous test sequences typically must be kept ready for use.

A dream team: R&S®SMBV100A and R&S®FSV for generating and analyzing digitally modulated signals



Support for all important state-of-the-art digital standards

With its internal baseband coder (R&S®SMBV-B10), the R&S®SMBV100A optionally allows users to generate all major digital communications standards – and without needing any external signal generation software. Alternatively, waveforms can be generated for the digital standards using the external R&S®WinIQSIM2™ software. Besides applying pre-defined test signals, users also have free access to individual signal parameters. Users can thus generate standard-compliant cellular or wireless signals.

Straightforward signal configuration due to easy-to-use GUI

During internal signal generation, the R&S®SMBV100A offers clear benefits due to its straightforward display and graphical user interface. The signal generator allows intuitive operation via the block diagram. The context-sensitive help system assists users during everyday work, e.g. when information is needed about individual parameters in the digital standards.

2G/3G/LTE mobile radio standards

Signals used in second- and third-generation mobile radio are as easy to generate with the R&S®SMBV100A as broadband LTE signals.

GSM/EDGE

- ▮ Framed and unframed signals
- ▮ Realtime signal generation (with R&S®SMBV-K40 only)
- ▮ Up to eight time slots with different modulation formats, training sequences and power levels
- ▮ All important burst types supported

CDMA2000®¹⁾/1xEV-DO

- ▮ Configuration of up to four base stations or four mobile stations
- ▮ Downlink CDMA2000® signal generation including all special channels, up to 78 user channels
- ▮ Operating modes "Traffic", "Access", "Enhanced Access" and "Common Control" on the CDMA2000® uplink
- ▮ Channel coding
- ▮ 1xEV-DO physical layer subtypes 0&1 or 2 supported

GUI of the R&S®SMBV100A showing the large variety of internally available digital standards (option)

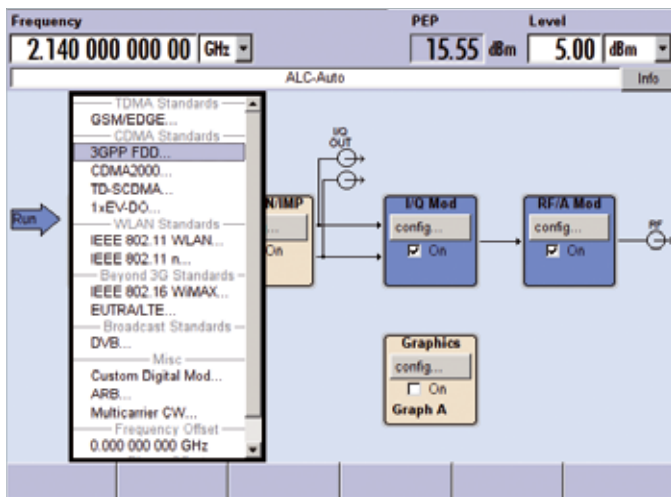

¹⁾ CDMA2000® is a registered trademark of the Telecommunications Industry Association (TIA - USA).

3GPP FDD/HSDPA/HSUPA/HSPA+

- Support of all physical channels of 3GPP FDD, HSDPA, HSUPA and HSPA+
- HSDPA H-sets 1 to 10 with channel coding plus user-definable H-sets
- HSUPA fixed reference channels with channel coding
- Realtime generation of P-CCPCH and up to three DPCHs in downlink (with R&S®SMBV-K42 only)
- One UE in realtime in uplink (with R&S®SMBV-K42 only), up to 67 additional mobile stations via ARB
- MIMO and transmit diversity coding

EUTRA/LTE

- Physical layer modes OFDMA and SC-FDMA for downlink and uplink supported
- Supported physical channels include P-SYNC/S-SYNC, PDSCH, PBCH, PCFICH, PHICH, PDCCH, PUSCH and PUCCH
- MIMO and transmit diversity coding
- Channel coding

Wireless standards including mobile WiMAX and WLAN IEEE 802.11n

The trend toward higher and higher data rates is raising the test requirements placed even on wireless systems. Here too, the R&S®SMBV100A provides all test signals needed.

WiMAX IEEE 802.16

- Support for fixed and mobile WiMAX
- Physical layer modes: OFDM, OFDMA, OFDMA/WiBro
- Burst types including FCH, DL-MAP, UL-MAP, DCD, UCD, HARQ, ranging, fast feedback, data
- Multiple zones and segments (e.g. PUSC, FUSC, AMC, sounding)
- Diversity and MIMO coding (DL, UL)

WLAN IEEE 802.11

- Signal generation in line with IEEE 802.11a/b/g/n
- PDCC, CCK and OFDM modulation
- Bandwidths of up to 40 MHz supported
- Channel coding
- Legacy, Mixed and Greenfield modes as well as MIMO coding for IEEE 802.11n

Additional information

For detailed information on all supported digital standards, please refer to the digital standards data sheet (PB 5213.9434.22) available on the Rohde & Schwarz website (www.rohde-schwarz.com).

Graphical display of settings for digital standards, e.g. EUTRA/LTE

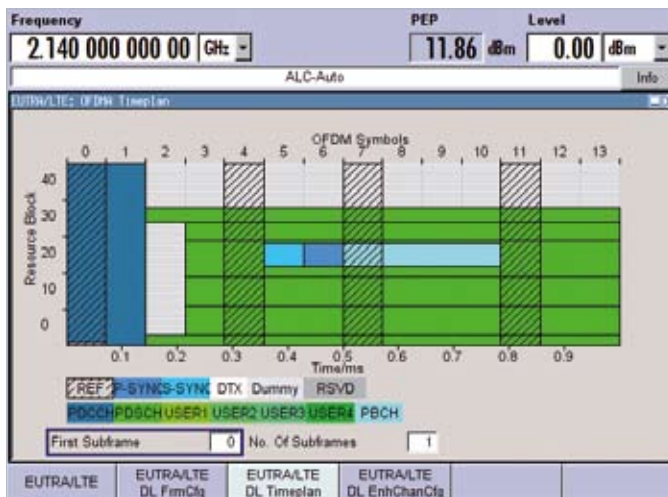

High-performance RF for all types of applications

A well-designed RF unit provides a solid basis for fast, clean digital signal generation. This is necessary to allow reproducible measurements with the digital signals used in development and production environments.

Excellent phase noise ensures low EVM with digital signals

SSB phase noise is a key parameter when it comes to RF generator signal quality. This parameter is important not only in CW applications, but also particularly with digital signals. It has a direct influence on the error vector magnitude (EVM) of digital signals, which is an important parameter especially with today's OFDM-based communications systems such as WiMAX and LTE.

The good signal characteristics provided by the R&S®SMBV100A also include excellent figures for nonharmonics, which are important when making interference measurements.

High output level compensates for losses in test/system setup

Test signals not only need to be pure; they must have sufficient power levels as well. This becomes obvious particularly when working with more complex systems in which the actual test setup (cables, switches, couplers, etc.) introduces losses between the generator and DUT. The R&S®SMBV100A can easily compensate for such losses with its high output power. With a specified output power of greater than +18 dBm (PEP) and typically even +24 dBm over a wide frequency range of 1 MHz to 6 GHz, the instrument delivers unparalleled performance in the mid-range class. This eliminates the need for external amplifiers, which not only drive up costs but also increase the system's level uncertainty.

Measured SSB phase noise with internal OCXO (R&S®SMBV-B1 option)

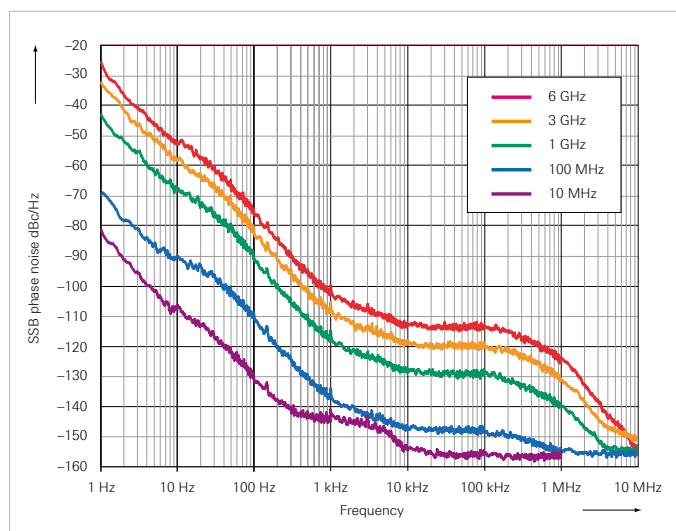

Measured maximum output power vs. frequency

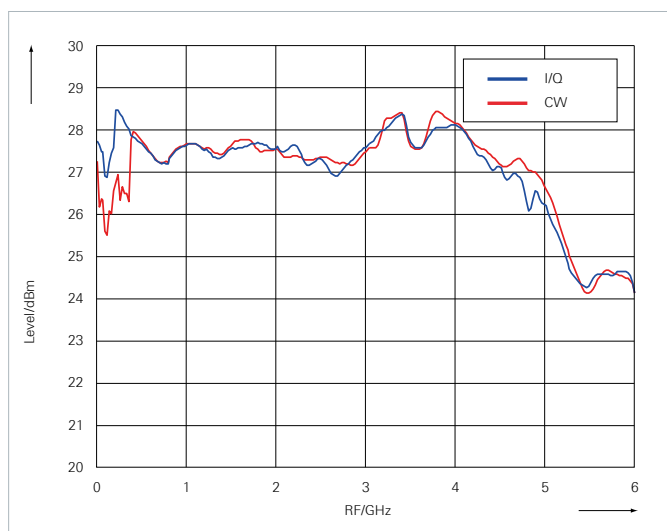

Fast settling time for quicker measurements

In production as well as in module characterization, numerous test points in the frequency and level domain are scanned. However, scans of this sort are only as fast as the slowest element in the chain. The R&S®SMBV100A makes a solid contribution with switching times of less than 1 ms in the standard List mode, thus helping to reduce the test time. This speeds up tests in development and helps to achieve throughput objectives in production at minimum costs.

Analog modulation for basic measurements

Analog modulation modes are also required in order to make the R&S®SMBV100A an all-purpose generator. This is why amplitude, frequency and phase modulation are all standard features. The R&S®SMBV100A also offers an internal LF source that can be used as a modulation generator.

The analog modulation capabilities can be enhanced even further with an optional pulse modulator and generator that offers an impressive rise/fall time of typically only 4 ns and a maximum on/off ratio of typically 90 dB.

Key features	
Low SSB phase noise	typ. -128 dBc (1Hz) at 1 GHz
Very low nonharmonics	typ. -85 dBc up to 1.5 GHz
Maximum output power	typ. +24 dBm
Fast frequency changes	<1 ms in List mode
Standard modulation modes	AM, FM, φM
Pulse modulation	optional

Histogram of measured level setting times in I/Q mode

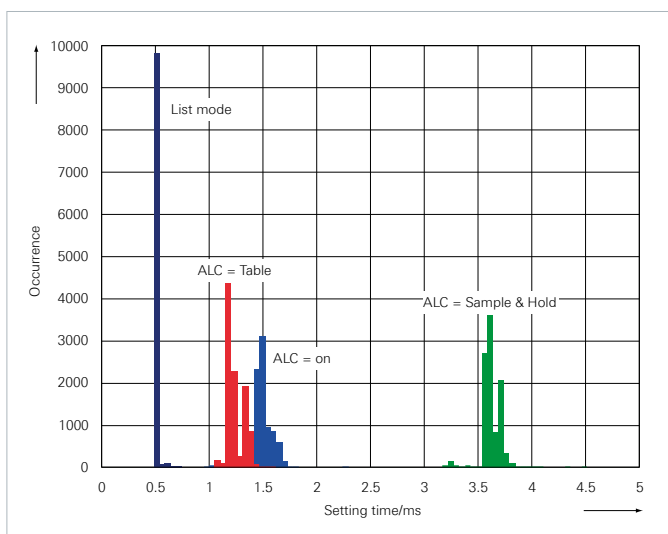

Flexible signal processing and baseband connectivity

Key features

Realistic scenarios with AWGN or CW interferer simulation

Flexible baseband outputs

Support for R&S®EX-IQ-Box digital interface adapter

CW interference and AWGN simulation

The baseband section can also be enhanced with an option for additive white Gaussian noise (AWGN), which permits realistic tests involving noisy signals.

The Noise Only and CW Interferer modes extend the generator's range of applications. In the Noise Only mode, the R&S®SMBV100A behaves like a defined noise source with adjustable bandwidth and level. The CW Interferer mode allows the internal addition of a CW carrier to the wanted signal, eliminating the need for an additional signal generator. This function is very useful for measuring adjacent channel suppression on receivers.

Analog and digital baseband outputs

To extend the range of applications of the optional internal baseband generators, they have analog differential I/Q outputs as a standard feature. This means that the R&S®SMBV100A can test the baseband section as well as the RF input of a DUT via its analog interface.

Support for R&S®EX-IQ-Box digital interface adapter

The baseband interface also offers an optional digital signal output¹⁾ that operates together with the R&S®EX-IQ-Box. The R&S®EX-IQ-Box makes adaptation to the device under test an easy task because it supports numerous common digital formats. The R&S®EX-IQ-Box is conveniently operated via the user interface of the R&S®SMBV100A.

¹⁾ Available starting in January 2009 (enabled via software).

Superposition of LTE signal with AWGN

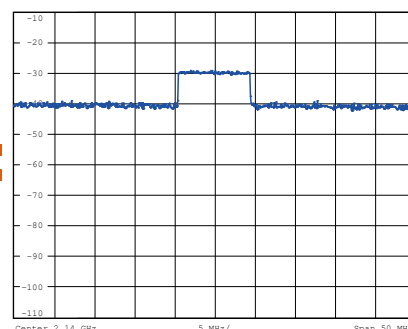
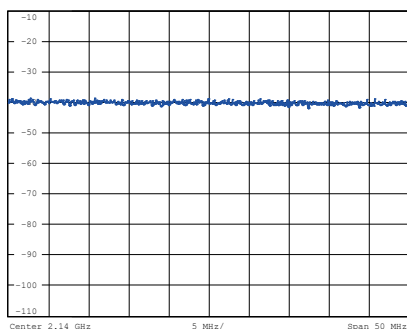
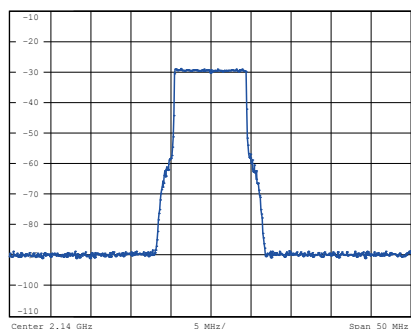

Low cost of ownership due to simple service concept

Key features

- Choice between on-site service and Rohde&Schwarz service center
- Long calibration interval of three years
- Modular design allows fast repairs

Fast on-site servicing

The R&S®SMBV100A has been designed for maximum dependability and easy servicing. This helps to maximize uptime in a wide variety of applications, which in turn means lower cost of ownership for the customer.

In addition, customers can choose between calibrating or repairing the instrument themselves or having a certified Rohde&Schwarz service center do the work. This helps customers to minimize downtime and to return the instrument to operation again as fast as possible. This is especially critical in production applications.

Long calibration interval (three years) minimizes service costs

Due to the stability of the components and modules that are used, the recommended calibration interval is three years. This minimizes the frequency of servicing, helping to save costs and ensure maximum uptime for the instrument.

Straightforward modular design for short repair times

In cases where repairs are actually necessary, internal error diagnostics help to pinpoint the problem. The design uses a minimum number of modules to simplify and speed up the exchange process. Since all modules have already been fully adjusted, a brief functional check is all that is necessary in order to restore the outstanding characteristics of the R&S®SMBV100A. If you also use a power sensor such as the R&S®NRP-Z92 to perform a new power level adjustment for the entire instrument, you can further increase the level accuracy.

Allrounder and specialist at the same time

Key features

- Short switching times of <1 ms in List mode
- Multisegment waveform mode for fast switchover between test sequences
- High level repeatability ensures stable test conditions
- High output power allows substitution of additional power amplifiers

Optimized for high production throughput

Several characteristics are important for achieving high throughput in production. The fast frequency and level switching times provided by the R&S®SMBV100A (<1 ms in List mode) provide a solid foundation. However, to allow fast switching of digital signals as well, the R&S®SMBV100A supports the multisegment waveform (MSW) mode. The MSW mode makes it possible to switch between multiple test sequences that are kept stored in memory simultaneously. Switching is controlled based on a user-specified schedule or by external triggering. With a memory depth of up to 256 Msamples, it is possible to switch between a number of different signals without having to waste time loading the data. Typical switching times are a brief $5 \mu\text{s}$ at a clock rate of 50 MHz. This is important when testing the advanced multimode modules that are used to process the different signals in GSM and 3GPP FDD.

Another important item is the level repeatability, which determines whether it is possible to obtain stable test conditions. The R&S®SMBV100A offers performance that makes it possible to set tighter measurement limits and thus increase the test yield.

Since higher level losses typically occur in more complex production systems, the R&S®SMBV100A offers a high output power of $>+18$ dBm, and typically even $+24$ dBm over the entire frequency range above 1 MHz. This eliminates the need for additional amplifiers, thereby saving space and money and helping to avoid loss of level accuracy on the DUT due to drift.

Multisegment waveform concept

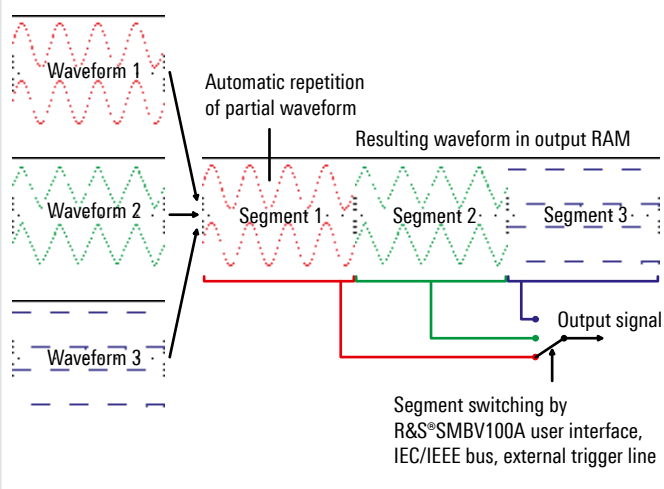

Level repeatability

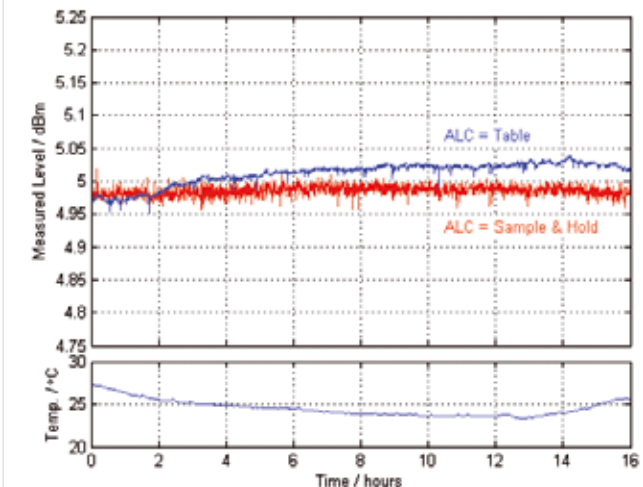

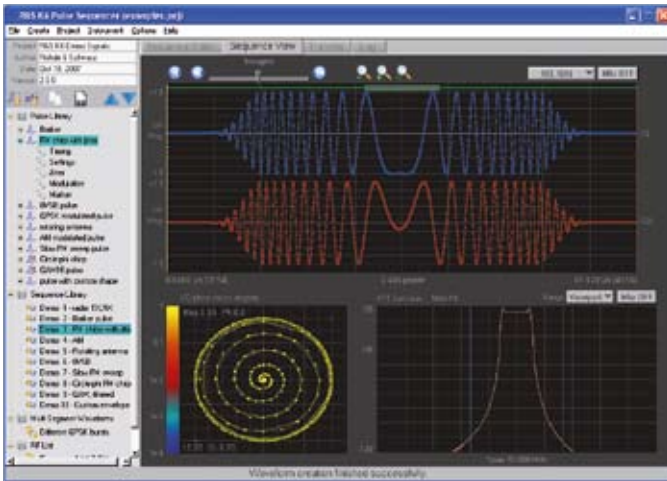

Key features

- Optional pulse modulator with 90 dB on/off ratio
- Support for R&S®SMBV-K6 pulse sequencer software
- Optional coupling of multiple instruments for generation of phase-coherent RF signals

Prepared for aerospace and defense applications

The R&S®SMBV100A offers two choices when it comes to generating typical pulse scenarios. The classic method uses an optional pulse generator and RF pulse modulator for a maximum on/off ratio of typically 90 dB. The other choice involves pulse generation using an I/Q modulator and an ARB signal for maximum flexibility in terms of pulse shapes and sequences. The optional R&S®SMBV-K6 pulse sequencer allows the easy generation of a wide range of realistic pulse sequences. With a high clock rate of up to 150 MHz, it generates pulses with steep edges while also supporting standard frequency hopping techniques with up to 120 MHz bandwidth.

During measurements on phased array antenna systems, the phase coherence option provides useful support. Multiple generators can be coupled to a common local oscillator to generate the signals needed for beamforming.

If the generator is used in a secure area, sanitizing procedures help to support the clearance procedure. The optional hard disk used to store signal data can be easily removed without opening the instrument.

Rear view of the R&S®SMBV100A



Specifications in brief

Base unit		
Frequency		
Range	R&S®SMBV-B103	
	CW mode	9 kHz to 3.2 GHz
	I/Q mode	1 MHz to 3.2 GHz
	R&S®SMBV-B106	
	CW mode	9 kHz to 6 GHz
	I/Q mode	1 MHz to 6 GHz
Setting time	SCPI mode, ALC state ON, CW mode	<3 ms
	SCPI mode, ALC state ON, I/Q mode	<5 ms
	SCPI mode, ALC state Table	<2 ms
	SCPI mode, ALC state S&H	<7 ms
	List mode	<1 ms
Level		
Maximum output power	1 MHz < f ≤ 6 GHz	>+18 dBm (PEP) ²⁾
Absolute level error	1 MHz < f ≤ 3 GHz	<0.5 dB
Additional level error with ALC OFF, S&H	This mode is used with I/Q modulation and pulse modulation.	<0.25 dB
Output impedance VSWR in 50 Ω system	200 kHz < f ≤ 6 GHz	<1.8
Setting time	SCPI mode, ALC state ON, CW mode	<2.5 ms
	SCPI mode, ALC state ON, I/Q mode	<5 ms
	SCPI mode, ALC state Table	<2 ms
	SCPI mode, ALC state S&H	<7 ms
	List mode	<1 ms
Reverse power	1 MHz < f ≤ 1 GHz	50 W
	1 GHz < f ≤ 2 GHz	25 W
	2 GHz < f ≤ 6 GHz	10 W
Spectral purity		
Harmonics	f > 1 MHz; CW, level ≤ 8 dBm	<-30 dBc
Nonharmonics	CW, level > -10 dBm, >10 kHz carrier offset, f ≤ 1500 MHz	<-70 dBc (nominal <-85 dBc)
SSB phase noise	20 kHz carrier offset, 1 Hz measurement bandwidth, CW	
	f = 100 MHz	<-141 dBc (nominal -147 dBc)
	f = 1 GHz	<-122 dBc (nominal -128 dBc)
	f = 6 GHz	<-106 dBc (nominal -112 dBc)
Wideband noise	attenuator mode AUTO for level > 5 dBm, >10 MHz carrier offset, 1 Hz measurement bandwidth, CW	<-142 dBc (nominal -152 dBc)
Supported analog modulation modes		
Amplitude modulation		standard
Frequency/phase modulation		standard
Maximum FM deviation	f > 3 GHz	16 MHz
Maximum φM	f > 3 GHz	160 rad
Pulse modulation		optional, with R&S®SMBV-K22
On/off ratio		>80 dB
Rise/fall time	10% to 90% of RF amplitude	<20 ns, typ. 4 ns
Minimum pulse width	using the optional R&S®SMBV-K23 pulse generator	10 ns

Base unit

I/Q modulation

Internally supported systems (with additional options)	R&S®SMBV-B10 baseband generator required	GSM/EDGE, 3GPP FDD incl. HSPA/HSPA+, TD-SCDMA, CDMA2000®, 1×EV-DO, EUTRA/LTE, WiMAX, WLAN IEEE802.11a/b/g/n, GPS, XM Radio, HD Radio™ ³⁾ , DVB-H/DVB-T, multicarrier CW
Realtime custom digital modulation	R&S®SMBV-B10 baseband generator required	ASK, FSK, BPSK, QPSK, QPSK 45° offset, OQPSK, π/4-QPSK, π/2-DBPSK, π/4-DQPSK, π/8-D8PSK, 8PSK, 8PSK EDGE, 16QAM, 32QAM, 64QAM, 256QAM, 1024QAM
I/Q modulator bandwidth	internal	60 MHz or 120 MHz, depending on baseband option
	external	>500 MHz
Maximum waveform length		32 Msamples
	with R&S®SMBV-B55 option	256 Msamples
DAC resolution		16 bit
ACLR	WCDMA 3GPP FDD, TM 1/64	typ. 67 dBc
EVM	WCDMA 3GPP FDD, TM 1/64	typ. 0.6%
	WiMAX IEEE802.16e	typ. 0.4%
	EUTRA/LTE	typ. 0.4%
Connectivity		
Remote control		IEC/IEEE, Ethernet (LAN), USB
Peripherals		USB 2.0

²⁾ PEP = peak envelope power.

³⁾ HD Radio™ is a proprietary trademark of iBiquity Digital Corp.

Ordering information

Designation	Type	Order No.
Base unit (including power cable, Quick Start Guide and CD-ROM, with operating and service manual)		
Vector Signal Generator	R&S®SMBV100A	1407.6004.02
Options		
RF		
9 kHz to 3.2 GHz	R&S®SMBV-B103	1407.9603.02
9 kHz to 6 GHz	R&S®SMBV-B106	1407.9703.02
Reference Oscillator OCXO	R&S®SMBV-B1	1407.8407.02
Phase Coherence	R&S®SMBV-B90	1407.9303.02
Pulse Modulator	R&S®SMBV-K22	1415.8019.02
Pulse Generator	R&S®SMBV-K23	1415.8025.02
Baseband		
Baseband Generator with Digital Modulation (realtime) and ARB (32 Msample), 120 MHz RF bandwidth	R&S®SMBV-B10	1407.8607.02
Baseband Generator with ARB (32 Msample), 120 MHz RF bandwidth	R&S®SMBV-B50	1407.8907.02
Baseband Generator with ARB (32 Msample), 60 MHz RF bandwidth	R&S®SMBV-B51	1407.9003.02
Memory Extension for ARB to 256 Msample	R&S®SMBV-B55	1407.9203.02
Hard Disk (removable)	R&S®SMBV-B92	1407.9403.02
Digital Baseband Connectivity ³⁾	R&S®SMBV-K18	1415.8002.02
Digital modulation systems		
Digital Standard GSM/EDGE	R&S®SMBV-K40	1415.8031.02
Digital Standard 3GPP FDD	R&S®SMBV-K42	1415.8048.02
3GPP FDD Enhanced MS/BS Tests incl. HSDPA	R&S®SMBV-K43	1415.8054.02
3GPP FDD HSUPA	R&S®SMBV-K45	1415.8077.02
Digital Standard CDMA2000® incl. 1xEV-DV	R&S®SMBV-K46	1415.8083.02
Digital Standard 1xEV-DO Rev. A	R&S®SMBV-K47	1415.8090.02
Digital Standard IEEE802.11 (a/b/g)	R&S®SMBV-K48	1415.8102.02
Digital Standard IEEE802.16	R&S®SMBV-K49	1415.8119.02
Digital Standard TD-SCDMA	R&S®SMBV-K50	1415.8125.02
TD-SCDMA Enhanced BS/MS Tests	R&S®SMBV-K51	1415.8131.02
Digital Standard DVB-H/DVB-T	R&S®SMBV-K52	1415.8148.02
Digital Standard IEEE802.11n	R&S®SMBV-K54	1415.8160.02
Digital Standard EUTRA/LTE	R&S®SMBV-K55	1415.8177.02
Digital Standard HSPA+	R&S®SMBV-K59	1415.8219.02
Multicarrier CW Signal Generation	R&S®SMBV-K61	1415.8225.02
Digital modulation systems using R&S®WinIQSIM2™ ⁴⁾		
Digital Standard GSM/EDGE	R&S®SMBV-K240	1415.8231.02
Digital Standard 3GPP FDD	R&S®SMBV-K242	1415.8248.02
3GPP FDD Enhanced MS/BS Tests incl. HSDPA	R&S®SMBV-K243	1415.8254.02
Digital Standard GPS	R&S®SMBV-K244	1415.8260.02
3GPP FDD HSUPA	R&S®SMBV-K245	1415.8277.02
Digital Standard CDMA2000® incl. 1xEV-DV	R&S®SMBV-K246	1415.8283.02
Digital Standard 1xEV-DO Rev. A	R&S®SMBV-K247	1415.8290.02
Digital Standard IEEE802.11 (a/b/g)	R&S®SMBV-K248	1415.8302.02
Digital Standard IEEE802.16	R&S®SMBV-K249	1415.8319.02

Designation	Type	Order No.
Digital Standard TD-SCDMA	R&S®SMBV-K250	1415.8325.02
TD-SCDMA Enhanced BS/MS Tests	R&S®SMBV-K251	1415.8331.02
Digital Standard DVB-H/DVB-T	R&S®SMBV-K252	1415.8348.02
Digital Standard IEEE 802.11n	R&S®SMBV-K254	1415.8354.02
Digital Standard EUTRA/LTE	R&S®SMBV-K255	1415.8360.02
Digital Standard HSPA+	R&S®SMBV-K259	1415.8377.02
Multicarrier CW Signal Generation	R&S®SMBV-K261	1415.8383.02
Additive White Gaussian Noise (AWGN)	R&S®SMBV-K262	1415.8425.02
Digital modulation systems using an external PC software or waveforms		
Pulse Sequencer ⁵⁾	R&S®SMBV-K6	1415.8390.02
Playback of XM Radio Waveforms ⁶⁾	R&S®SMBV-K256	1415.8402.02
Playback of HD Radio™ Waveforms	R&S®SMBV-K352	1415.8431.02
Noise generation		
Additive White Gaussian Noise (AWGN)	R&S®SMBV-K62	1415.8419.02
Recommended extras		
Hardcopy manuals (in English, UK)		1407.6062.32
Hardcopy manuals (in English, US)		1407.6062.39
19" Rack Adapter	R&S®ZZA-S334	1109.4487.00
Power Sensor 9 kHz to 6 GHz	R&S®NRP-Z92	1171.7005.02
Keyboard with USB Interface (US character set)	R&S®PSL-Z2	1157.6870.04
Mouse with USB Interface, optical	R&S®PSL-Z10	1157.7060.03

³⁾ Available starting in January 2009 (enabled via software).

⁴⁾ R&S®WinIQSIM2™ requires an external PC.

⁵⁾ The pulse sequencer requires an external PC.

⁶⁾ Signal generation requires waveforms from XM Radio.

Your local Rohde&Schwarz expert will help you to find the solution that is optimally suited to your requirements and will be glad to prepare a custom offer for you.

To find your nearest Rohde&Schwarz representative visit: www.sales.rohde-schwarz.com

Service you can rely on

- | In 70 countries
- | Person-to-person
- | Customized and flexible
- | Quality with a warranty
- | No hidden terms

About Rohde & Schwarz

Rohde & Schwarz is an independent group of companies specializing in electronics. It is a leading supplier of solutions in the fields of test and measurement, broadcasting, radiomonitoring and radiolocation, as well as secure communications. Established 75 years ago, Rohde & Schwarz has a global presence and a dedicated service network in over 70 countries. Company headquarters are in Munich, Germany.

Regional contact

Europe, Africa, Middle East

+49 1805 12 42 42* or +49 89 4129 137 74

customersupport@rohde-schwarz.com

North America

1-888-TEST-RSA (1-888-837-8772)

customer.support@rsa.rohde-schwarz.com

Latin America

+1-410-910-7988

customersupport.la@rohde-schwarz.com

Asia/Pacific

+65 65 13 04 88

customersupport.asia@rohde-schwarz.com



For data sheet, see
PD 5214.1114.22
and www.rohde-schwarz.com

Rohde & Schwarz GmbH & Co. KG

Mühlhofstraße 15 | 81671 München

Phone +498941 290 | Fax +498941 29 121 64

www.rohde-schwarz.com

R&S® is a registered trademark of Rohde & Schwarz GmbH & Co. KG
Trade names are trademarks of the owners | Printed in Germany (ed)
PD 5214.1114.12 | Version 01.00 | August 2008 | R&S®SMBV100A
Data without tolerance limits is not binding | Subject to change

*0.14 €/min within German wireline network; rates may vary in other networks (wireline and mobile) and countries.