

Anritsu envision : ensure

BERTWave™

MP2100B

BERTWave



**All
In One**

BERT+
Sampling Scope

4ch

~12.5 Gbit/s
BERT



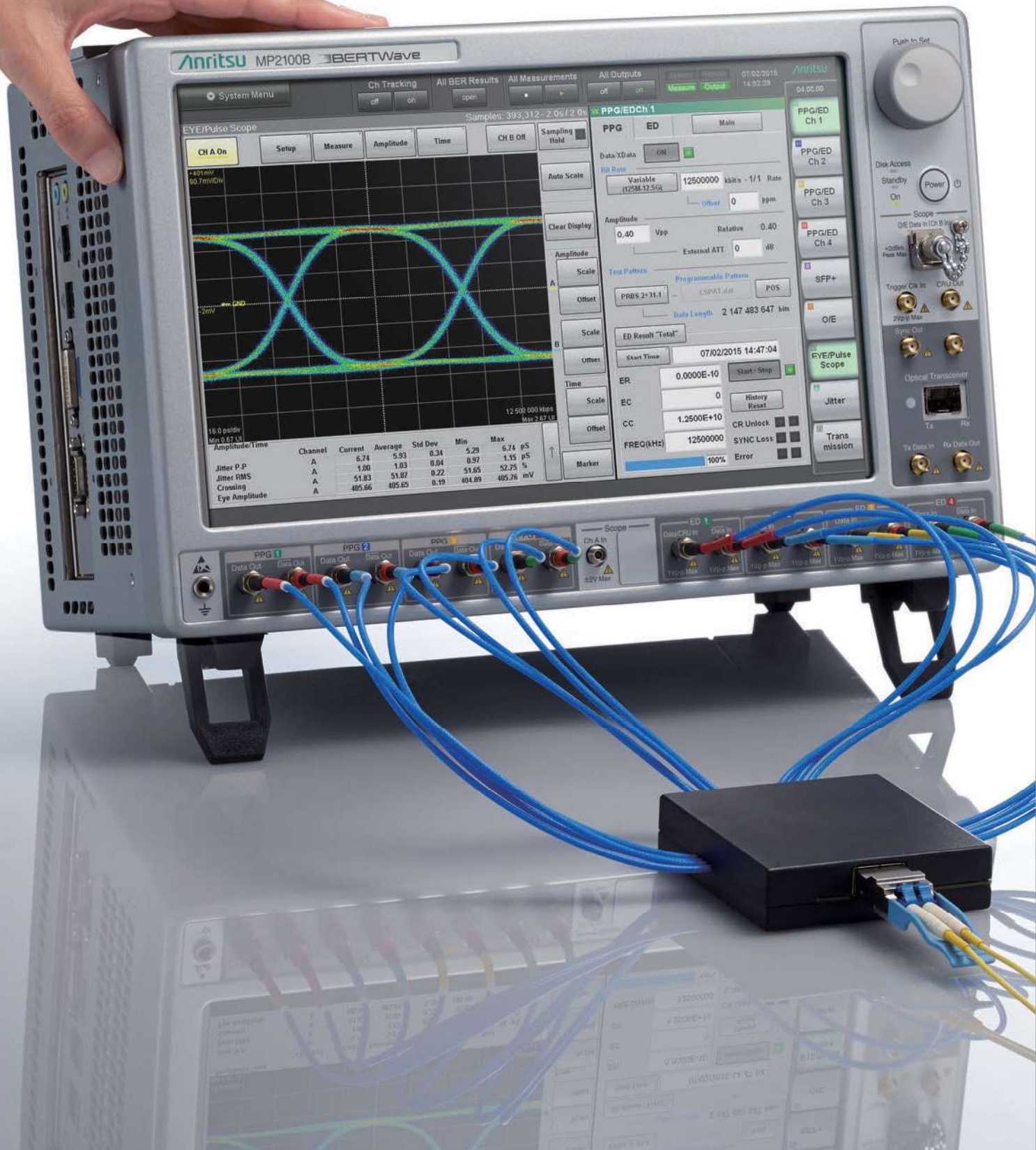

MP2100B

10 GbE × 4ch Big Value in Small Set

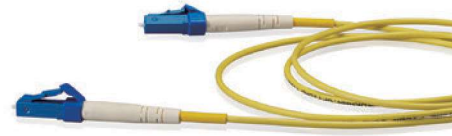

All-in-One 4ch BERT (12.5 Gbit/s max.) + Sampling Oscilloscope

Multi-channel Optical Module Test Solution
BERTWave MP2100B

Development and Manufacturing of Multi-channel Optical Modules for Data Centers

The spread of cloud computing is increasing demand for optical modules used in data centers. In particular, SFP+ modules for 10 GbE and QSFP+ modules for 40 GbE (10 Gbit/s × 4) are in high demand. The all-in-one BERTWave MP2100B has a built-in BERT (Bit Error Rate Tester) and sampling oscilloscope for running simultaneous BER tests and Eye Pattern analyses required for developing and manufacturing modules. The number of BERT channels can be expanded to four, all supporting simultaneous BER measurements. Additionally, the high sampling speed reduces the Eye Pattern measurement time. multi channel optical modules, such as QSFP+, can be measured more efficiently using the MP2100B.

All in One	Built-in BERT and Scope	1 ps rms Jitter	Pulse Pattern Generator (PPG) Jitter: 1 ps rms
4ch BERT	Built-in 1ch to 4ch 12.5 Gbit/s BERT	10 mVp-p Sensitivity	Error Detector (ED) Sensitivity: 10 mVp-p

Short Measurement Times

Simultaneous 4ch BERT and Eye Pattern Measurements
Simultaneous 4ch BER Measurements
High-Speed Eye Mask Tests
High-Speed BER Tests

Full-Featured Analysis Functions

Wideband Operation Frequency
Electrical and Optical Interfaces
Jitter Analysis
Clock Recovery

Cost-Effective Investment

Flexible Measurement System Configuration
Multi-channel BERT

Supported Applications

- InfiniBand (SDR, DDR, QDR), Fibre Channel (1G, 2G, 4G, 8G, 10G, 10G FEC)
- 1 GbE, 2 GbE, 10 GbE (WAN, LAN), XAUI (3.125 Gbit/s), 40 GbE (10 Gbit/s × 4)
- CPRI (× 1, × 2, × 4, × 5, × 8, × 10), OBSAI (RP3, RP3 × 2, RP3 × 4, RP3 × 8)
- OC-3 to OC-192/STM-1 to STM-64, OC-192/STM-64 FEC (ITU-T G.975), OTU-1, OTU-2, OTU-1e, OTU-2e
- CFP, CXP, QSFP/QSFP+, SFP/SFP+, XFP, Active Optical Cable (AOC), TOSA/ROSA

BERTWave MP2100B Features

All-in-One 4ch BER Measurements and Eye Pattern Analyses

Increasing the number of channels can greatly shorten measurement times for QSFP+ modules that might otherwise require long measurement times.

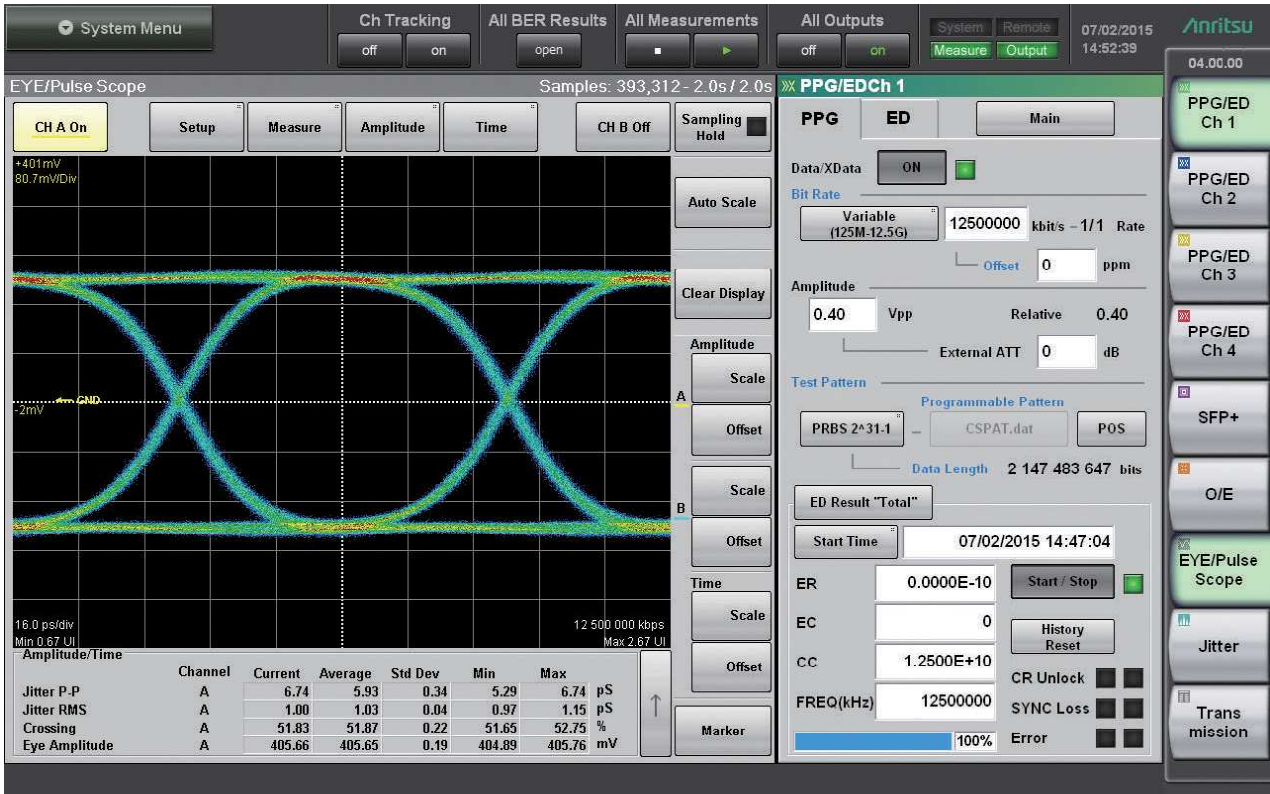

The all-in-one sampling oscilloscope with integrated BERT simplifies measurement system configuration and control to support simultaneous BER measurement and EYE pattern analysis, cutting measurement times by about 40% in comparison to combinations of separate instruments.

Furthermore, the BERTS expandability to 4ch supports simultaneous error measurement for all QSFP+ module channels, cutting measurement times by a further 70% because time-wasting channel switching operation is eliminated.

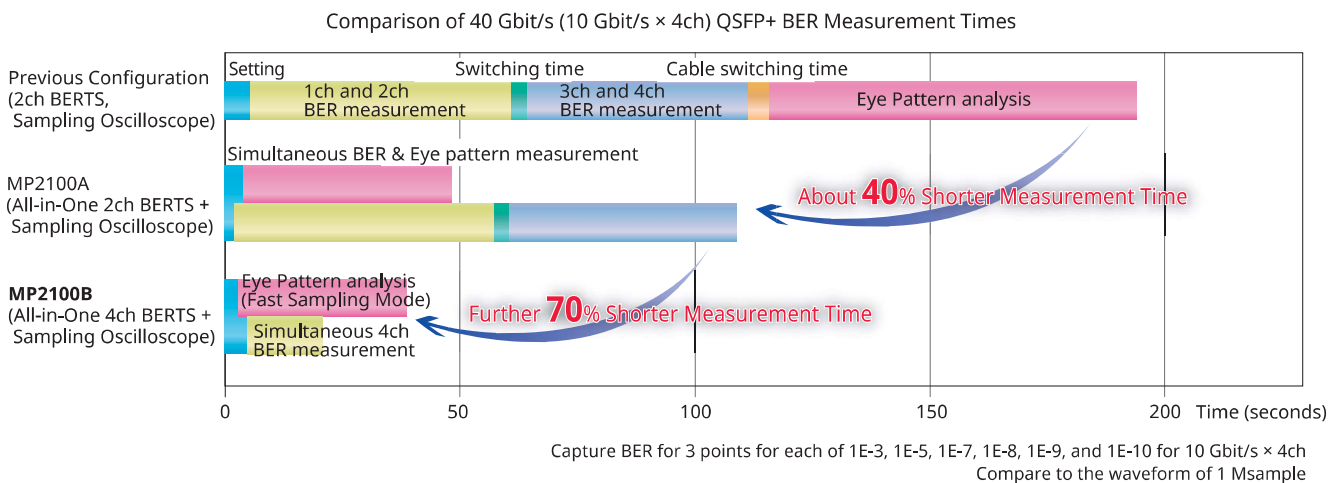

BERTWave MP2100B Features

Flexible Measurement System Configurations

Conventional measurement systems use a BERT as the signal source and a sampling oscilloscope for Eye pattern analysis in separate cabinets, which is complex. Incorporating the BERT and sampling oscilloscope into one MP2100B set offers an easy to configure measurement system.

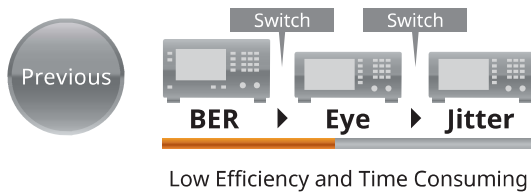

High-Speed BER Tests

The MP2100B uses a BERT Channel ranking function to support batch setting and measurement of up to 4ch. Additionally, it has a built-in standard function for batch capture of measurement results. As a result, it greatly shortens 40 GbE (10 Gbit/s × 4) QSFP+ BER measurement times. Moreover, capturing BER measurement results in 10-ms units, reduces measurement times too.



Fast Sampling Mode/High-Speed Eye Pattern Analysis

A new Fast Sampling Mode is built into the MP2100B as a standard function. As well as offering the same high-speed 100 ksampl/s sampling speed as legacy models, the new Fast Sampling Mode increases sampling speed 150 ksampl/s for 1.5 time faster Eye pattern analysis.

Wideband Operating Frequency

The built-in PPG and ED operate at 1/N bit rates over the range of 8.5 Gbit/s to 11.32 Gbit/s as standard. Installing option 092 supports all bit rates ranging from 125 Mbit/s to 12.5 Gbit/s used by various applications such as STM-1, 10GFC, etc., in one set.

Examples of Supported Bit Rates and Applications (with Option 092)

PPG/ED Supported Bit Rates	Application Example
125 Mbit/s to 12.5 Gbit/s	InfiniBand (SDR, DDR, QDR), Fibre Channel (1G, 2G, 4G, 8G, 10G, 10G FEC), GbE, 2 GbE, 10 GbE (WAN, LAN), XAUI (3.125G), 40 GbE (10 Gbit/s × 4), CPRI (×1, ×2, ×4, ×5, ×8, ×10), OBSAI (RP3, RP3 ×2, RP3 ×4, RP3 ×8), OC-3/STM-1, OC-12/STM-4, OC-24, OC-48/STM-16, OC-192/STM-64, OC-192/STM-64 FEC (G.975), OTU-1, OTU-2, OTU-1e, OTU-2e, SFP, SFP+, XFP, Active Optical Cable (AOC), QSFP/QSFP+, CFP, CXP, TOSA/ROSA

Examples of Supported Bit Rates and Applications (without Option 092)

PPG/ED Supported Bit Rates	Application Example
8.5 Gbit/s to 11.32 Gbit/s	<ul style="list-style-type: none"> • 8GFC • 10GbE • 10GFC • 40 GbE (10 Gbit/s × 4) • 10GFC FEC • 10 GbE FEC • OTU-2 • OC-192/STM-64 • OTU-2e • OC-192/STM-64 FEC • OTU-1e
4.25 Gbit/s to 5.66 Gbit/s	• 4GFC
2.125 Gbit/s to 2.83 Gbit/s	<ul style="list-style-type: none"> • 2GFC • 2 GbE • InfiniBand • OC-48/STM-16 • OTU-1
1.0625 Gbit/s to 1.415 Gbit/s	<ul style="list-style-type: none"> • 1 GbE • 1GFC
0.53125 Gbit/s to 0.7075 Gbit/s	• OC-12/STM-4
0.265625 Gbit/s to 0.35375 Gbit/s	
0.132812 Gbit/s to 0.176875 Gbit/s	• OC-3/STM-1

BERTWave MP2100B Features

Clock Recovery Function

ED Clock Recovery Function (Standard Function)

BER Analysis is supported by inputting the Data signal without requiring an external Clock.

Eye/Pulse Scope Clock Recovery Function (Option 053, 054, 055)

- Frequency range: 8.5 Gbit/s to 12.5 GHz, 0.1 Gbit/s to 2.7 GHz

This function can be used for evaluating optical characteristics such as long-distance transmission equipment without Clock output.

Time and Amplitude Tests

Supported measurements include 0 level, 1 level, SNR, Eye closure ratio, Eye amplitude, Eye height, Eye width, jitter p-p, jitter RMS, Extinction ratio, Rise time, Fall time, Duty cycle distortion, Average power, OMA, etc.

Amplitude/Time	Channel	Current	Average	Std Dev	Min	Max
Jitter P-P	A	8.17	8.17	0.00	8.17	8.17 pS
Jitter RMS	A	1.26	1.26	0.00	1.26	1.26 pS
Crossing	A	50.22	50.22	0.00	50.22	50.22 %
Eye Amplitude	A	355.93	355.93	0.00	355.93	355.93 mV

Histograms

Troubleshooting is made easier because waveform data component analysis can be performed using the mean, standard error, and scatter within the set data distribution.

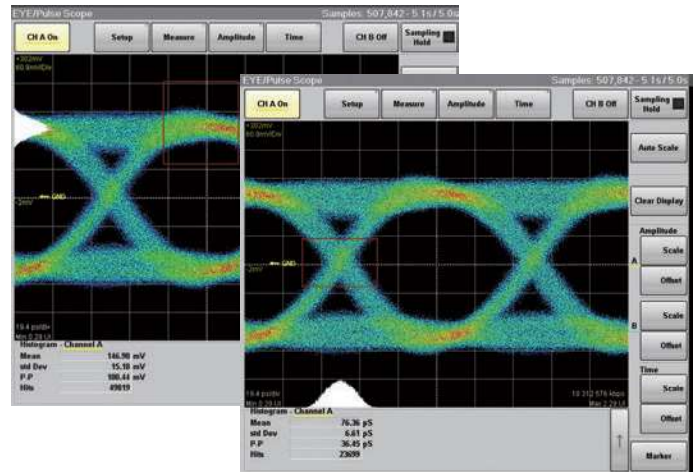

Eye Mask/Mask Margin Test

Testing is simple because Mask Margin tests are performed automatically. Furthermore, since the time required for Mask Margin tests is only about one second, line productivity is improved because standards-compliant measurements are performed at high speed in a shorter time.

- Automatic measurement within one second
- Real-time margin measurements
- Selectable Count and Rate at Mask Hit

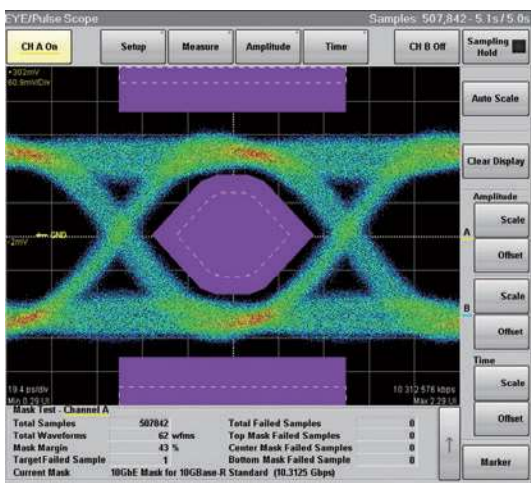

Reference Trace Function

Saving measured waveform data for reference enables comparison of current data with previous data.

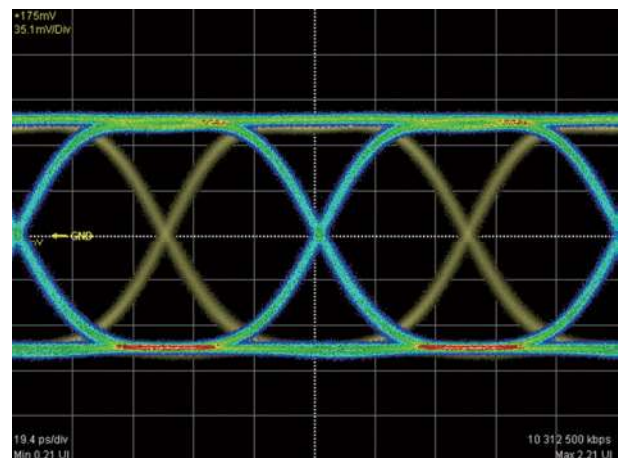

Simple Operation, High Durability, Eco-friendly Design

Improved Operability

- Easy-to-read, 12.1" wide display
- Easy touch-panel operation

Improved Reliability

- Uses flash disk
- Data loss is prevented using flash disk.

Compact, Eco-friendly Design

- Compact 18-cm deep design
- Dimensions: 341 (W) × 221.5 (H) × 180 (D) mm
- Lightweight (7 kg max.)

BERTWave MP2100B Applications

40 Gbit/s QSFP+ (10 Gbit/s × 4) Measurement

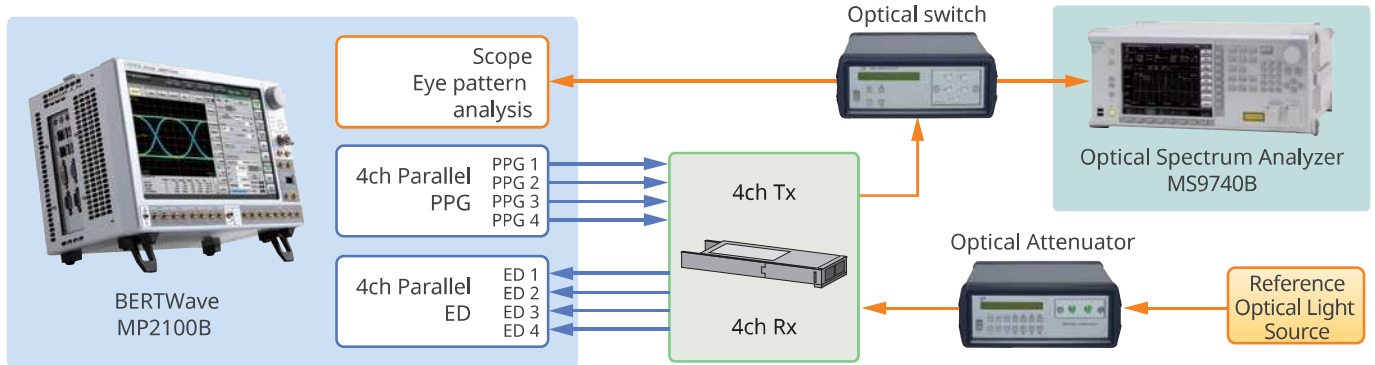

40 Gbit/s QSFP + Measurement Items

- Transmitter
 - Eye Pattern Measurements
 - Tr/Tf, Jitter, Mask Margin, etc.
 - Average Output Power
 - OMA
 - Extinction Ratio
- Receiver
 - BER Curve

Shorter Test Times with Simultaneous BER and Waveform Measurements

Multichannel optical modules such as QSFP+ are being deployed in data centers to cope with the explosive increase in data traffic. With a built-in 4ch BERT, the MP2100B supports simultaneous measurement of all QSFP+ channels. Moreover, since it has both a built-in BERT and oscilloscope, it can be used to monitor waveforms while also performing BER measurements, helping nearly halve test times.

Shorter Analysis Times using Automatic Waveform Measurements

Key parameters, such as Tr/Tf and Jitter, for clearly understanding waveform performance can be measured automatically. Mask Margin Pass/Fail evaluations are displayed along with Margin data such as bit errors and rates. These automated measurement functions play a major role in cutting monitored waveform quality-analysis time.

Higher Yields due to High-Quality PPG and High-Sensitivity ED

Accurate testing of DUT characteristics must avoid degrading the DUT characteristics due to the measuring instrument performance. The MP2100B PPG can output a high-quality signal with a Tr/Tf of 24 ps and a jitter of 1 ps. In addition, the ED has a high input sensitivity of 10 mVp-p min. This excellent performance helps improve DUT yields.

BERTWave MP2100B Applications

AOC (Active Optical Cable) Measurement

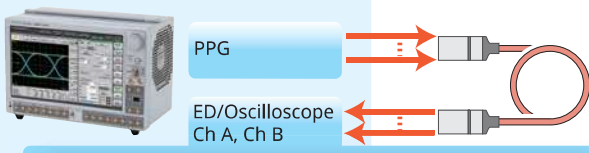

PPG

ED/Oscilloscope
Ch A, Ch B

- Simultaneous Required Measurements



- Detailed Jitter Analysis

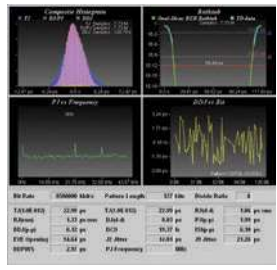

AOC (Active Optical Cable) Measurement Items

- BER
- Eye Pattern
Tr/Tf, Jitter, Mask Margin, etc.
- Jitter Analysis

Shorter Test Time using Multichannel BER Measurement

Since the MP2100B has a built-in 4ch BERT it can measure the BER of all four AOC lanes at once, helping cut test times.

Shorter Test Time using High-Speed Jitter Analysis Function

AOC are not evaluated using just the Eye pattern — Jitter analysis is also required.

Using the Jitter Analysis Software MX210001A in combination with the MP2100B supports simultaneous Jitter analysis, Eye Pattern, and Eye Mask tests, helping cut test times.

Simultaneous Eye Pattern and Eye Mask, Jitter Analysis Measurements

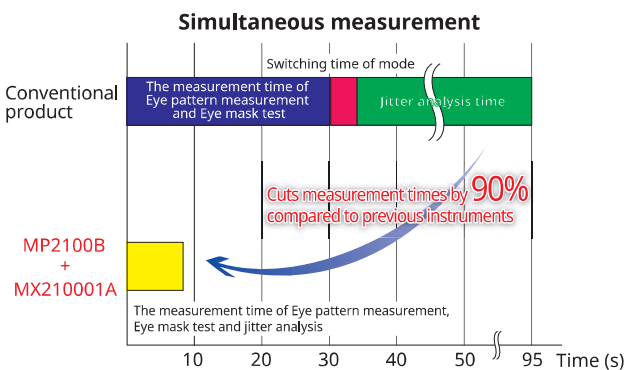

PON Device BOB (BOSA On Board) Evaluations

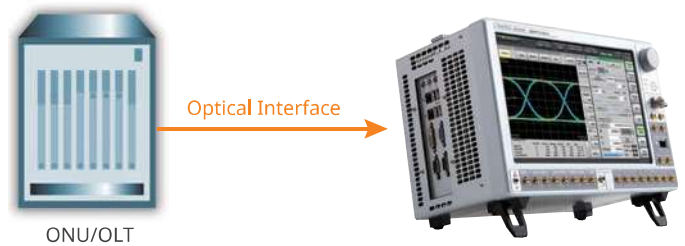

PON Transmission Equipment Measurement Items

- Eye Pattern
Tr/Tf, Jitter, Mask Margin, etc.

Simple Test System using Clock Recovery

Commonly, transmission equipment does not output a trigger signal, but since the MP2100B has a built-in Clock Recovery option, a waveform monitoring system can be configured using only the MP2100B.

Shorter Test Time using High-Speed Mask Margin Measurement

The MP2100B has a new Fast Sampling Mode built-in as standard. It increases the sampling speed from 100 ksamples/s to 150 ksamples/s, helping shorten test times by increasing the Eye pattern screen drawing speed.

Difference in Eye Mask Screen Drawing Time due Sampling Speed

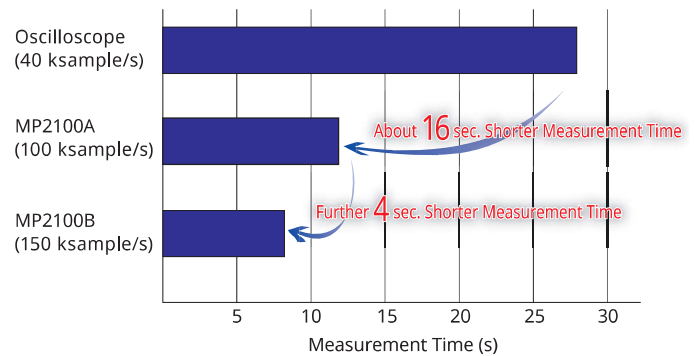

BERTWave MP2100B Configuration

MP2100B Block Diagram

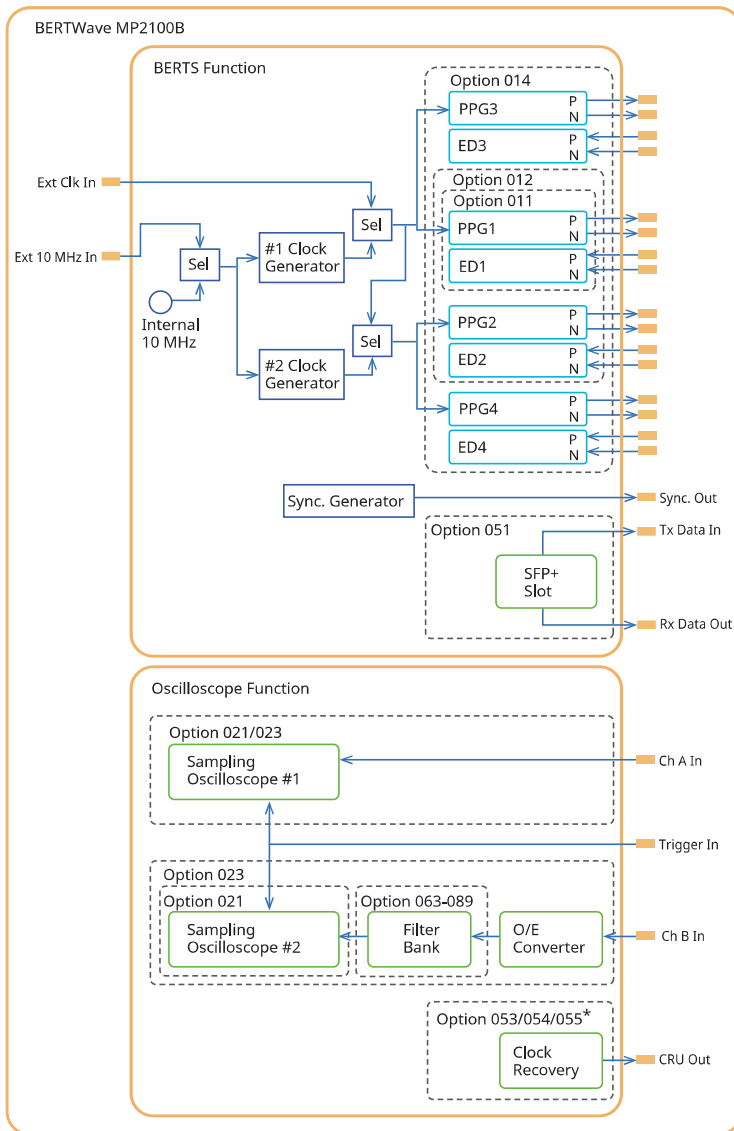

*: For details, refer to Clock Recovery Option Block Diagram.

List of Interface Option Configurations

	Interface	Option
BERT	1ch	MP2100B-011
	2ch	MP2100B-012
	4ch	MP2100B-014
	Optical (SFP+ Slot)	MP2100B-051
Oscilloscope	Differential Electrical Input	MP2100B-021
	O/E Input	MP2100B-023

List of Option Configuration by Application

	Application	Option
BERT	1ch BER Measurement	MP2100B-011
	2ch BER Measurement	MP2100B-012
	4ch BER Measurement	MP2100B-014
	Crosstalk Test	MP2100B-012 or MP2100B-014
	Optical BER Measurement	MP2100B-051 is added
	Wide bandwidth Variable BER Measurement	MP2100B-092 is added
Oscilloscope	Electrical Signal Eye Pattern Analysis	MP2100B-021
	Optical Signal Eye Pattern Analysis	MP2100B-023
	Optical LPF	MP2100B-063 to 089 are added
	Clock Recovery Electrical Waveform Monitoring	MP2100B-053 or 055 is added
	Clock Recovery Electrical Waveform Monitoring	MP2100B-054 is added
	Jitter Analysis	MX210001A is added

Clock Recovery Option Block Diagram

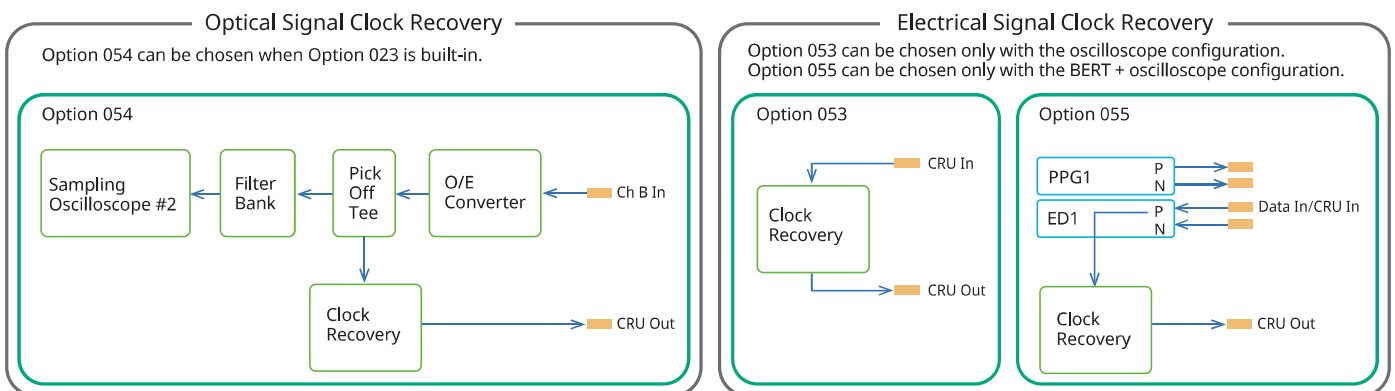

BERTWave MP2100B Selection Guide

Configuration List

Model Number	Model Name	Note
MP2100B	BERTWave	
MP2100B-011	1CH BERT	BERT-only Required Select any one of Option 011, 012, and 014.
MP2100B-012	2CH BERT	
MP2100B-014	4CH BERT	Scope-only Required Select any one of Option 021 and 023.
MP2100B-021	Dual Electrical Scope	Scope and BERT Required
MP2100B-023	Optical and Single-ended Electrical Scope*	Select any one of Option 011, 012, and 014, and any one of Option 021 and 023.
MP2100B-030	GPIO	
MP2100B-051	SFP+ Slot	This can be selected only when Option 011, 012, or 014 is installed.
MP2100B-053	Clock Recovery (External Input)	This can be selected only when Option 021 or 023 is installed.
MP2100B-054	Clock Recovery (Optical Data)	Select any one of following options as necessary. Option 053 can be used only when the oscilloscope option is installed.
MP2100B-055	Clock Recovery (with BER Measurement)	Option 054 can be used only by optical signal clock recovery. Option 055 can be used only when the BERT option is installed.
MP2100B-092	PPG/ED Bit Rate Extension for 125M to 12.5G	This can be selected only when select Option 011, 012, or 014.

*: When selecting Option 023, always specify the connector type (either Option 037 FC or Option 040 SC).

BERTWave MP2100B Selection Guide

Filter Bank Configuration Table

Filter Bank		Low Bit Rate Filter					High Bit Rate Filter						
		MP2100B-070	MP2100B-071	MP2100B-072	MP2100B-073	MP2100B-075	MP2100B-076	MP2100B-078	MP2100B-079	MP2100B-080	MP2100B-081	MP2100B-082	MP2100B-086
		156 bit/sM	622 Mbit/s	1.0 Gbit/s	1.2 Gbit/s	2.5 Gbit/s	2.1 Gbit/s	2.6 Gbit/s	3.1 Gbit/s	4.2 Gbit/s	5.0 Gbit/s	6.2 Gbit/s	8.5 Gbit/s to 11.3 Gbit/s
MP2100B-063	High Rate Filter Bank	—	—	—	—	—	Up to four can be selected.						
MP2100B-065	Low Rate Filter Bank	Up to four can be selected.					—	—	—	—	—	—	—
MP2100B-069	Multi Rate Filter Bank	Up to three can be selected.					Up to three can be selected.						
MP2100B-087	Filter Bank and Filter Set (622M/1.2G/2.5G/4.2G/6.2G/Multi 10G)		✓		✓	✓				✓		✓	✓
MP2100B-088	Filter Bank and Filter Set (4.2G/5.0G/6.2G/ Multi 10G)								✓	✓	✓	✓	
MP2100B-089	Filter Bank and Filter Set (156M/622M/1.2G/2.5G)	✓	✓		✓	✓							

The filter can be selected only when Option 023 is built-in. Choose any of the following methods.

1. Choose one filter bank and one or more filters.
2. Choose the filter bank and one set of filters.

- ★ A filter bank cannot be chosen alone without filters.
- ★ If No Filter is required, configure any of the following.
 - Without any filter
 - Choose Option 086 and set Filter to Off.

BERTWave MP2100B Key Layout

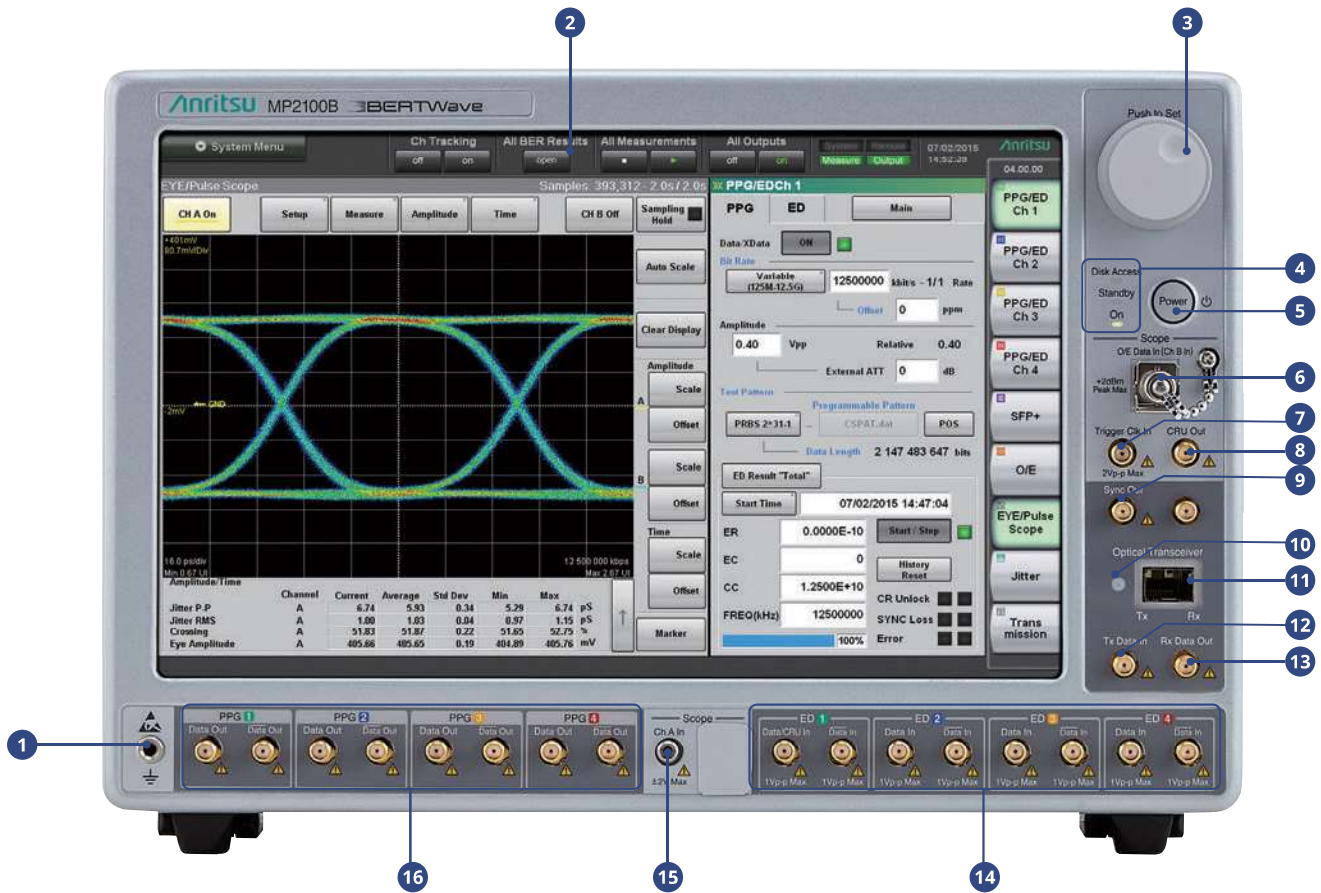

- 1 Earth Terminal**
Connect to wrist strap to prevent static electricity hazards
- 2 Display**
12.1-inch touch panel display
- 3 Rotary Encoder**
Changes settings by turning knob
- 4 Disk Access LED, Standby LED, Power LED**
- 5 Power Switch**
- 6 Optical Input Connector**
Used when Option 023 selected
- 7 Sampling Oscilloscope Trigger Input Connector**
Used when Option 021 or 023 selected
- 8 Clock Recovery Unit Output Connector**
Used when Option 053, 054 or 055 selected
- 9 Sync Pulse Output Connector**
Used when Option 011, 012, or 014 selected
- 10 Optical Output Indicator LED**
Used when Option 051 selected
- 11 Optical Transceiver Slot**
Used when Option 051 selected
- 12 Optical Transceiver Tx Signal Input Connector**
Used when Option 051 selected
- 13 Optical Transceiver Rx Signal Output Connector**
Used when Option 051 selected
- 14 Error Detector Input Connector**
Panel when Option 014 selected
Can use ED 1 only when Option 011 selected
Can use ED 1 and ED 2 only when Option 012 selected
- 15 Sampling Oscilloscope Input Connector**
Panel when Option 023 selected
Ch A In can only be used when Option 023 is selected.
Ch B In can only be used when Option 021 is selected.
- 16 PPG Output Connector**
Panel when Option 014 selected
Can use PPG 1 only when Option 011 selected
Can use PPG 1 and PPG 2 only when Option 012 selected

BERTWave MP2100B Key Layout

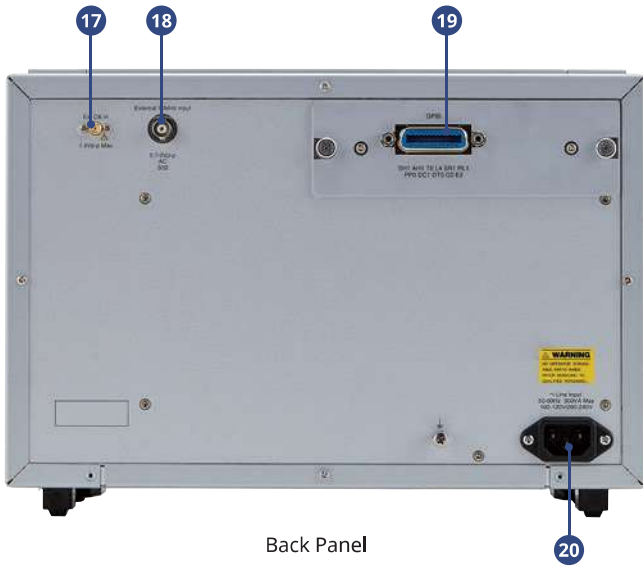

Back Panel

- 17 **External Clock Input**
Can be used when Option 011/012/014 selected
- 18 **10 MHz Clock Input**
Can be used when Option 011/012/014 selected
- 19 **GPIB Connector**
Can be used when Option 030 selected
- 20 **Power Input Connector**

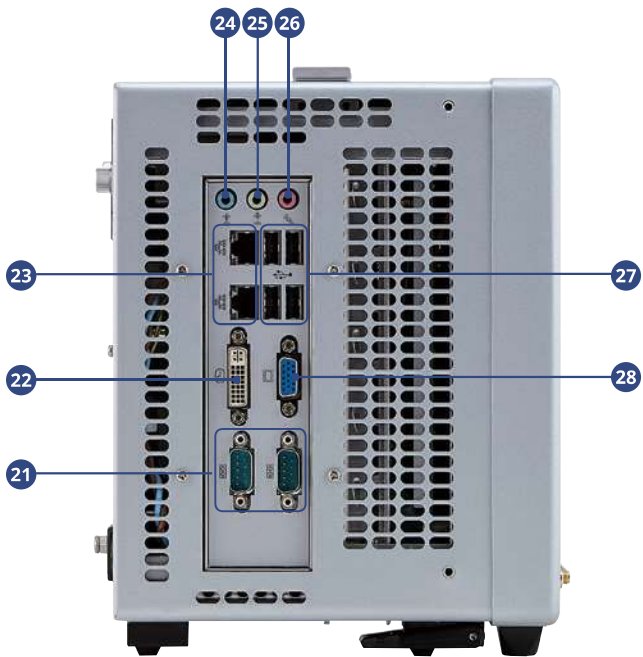

Left Side Panel

- 21 **Serial Interface**
- 22 **Monitor Output (DVI-I)**
- 23 **Ethernet**
- 24 **Line IN**
- 25 **Line OUT**
- 26 **Microphone IN**
- 27 **USB**
- 28 **Monitor OUT (D-Sub 15-pin)**

BERTWave MP2100B Specifications

Common

Input Devices	Rotary encoder, touch panel, power switch	
LCD	12.1-inch WXGA (1280 × 800)	
Remote Interfaces	Ethernet, GPIB (Option 030)	
Peripheral Connectors	VGA Out (SXGA), Digital Video Interface, USB (4Port, Revision 2.0), Ethernet (2Port, 10/100/1000BASE-T)	
OS	Windows embedded standard 2009	
Internal Storage Media	Flash Memory, 8 GB min.	
Power Supply	100 V(ac) to 120 V(ac)/200 V(ac) to 240 V(ac), (auto-switching), 50 Hz/60 Hz	
Power Consumption	300 VA max.	
Temperature Range	Operating: +5° to +40°C Storage: -20° to +60°C	
Dimensions	341 (W) × 221.5 (H) × 180 (D) mm (excluding projections)	
Mass	7 kg max. (with MP2100B-012, and 021 and excluding other options)	
CE	EMC	2014/30/EU, EN61326-1, EN61000-3-2
	LVD	2014/35/EU, EN61010-1
	RoHS	2011/65/EU, EN50581

BERT

External 10 MHz IN Connector	Amplitude: 0.7 Vp-p to 2 Vp-p, AC coupled Connector: BNC, 50Ω Waveform: Square or Sine wave		
External Reference Clock IN	External 1/16 Clock input Amplitude: 0.2 Vp-p to 1.6 Vp-p, AC coupled Connector: SMA, 50Ω Waveform: Square or Sine wave		
Sync OUT	Output level: VOL: -0.5 to -0.3 V, VOH: -0.1 to 0 V, 0.4 Vp-p (typ.) Connector: SMA, 50Ω		
	Bit rates (Option 092 not installed)	PPG	ED
	8.5G to 11.32G	1/4 Clock, 1/8 Clock, 1/16 Clock, 1/64 Clock, PPG pattern sync	1/8 Clock, 1/16 Clock
	1/2 Rate	1/2 Clock, 1/4 Clock, 1/16 Clock, PPG pattern sync	1/4 Clock, 1/16 Clock
	1/4 Rate	1/1 Clock, 1/2 PPG Clock, 1/16 PPG Clock, PPG pattern sync	—
	1/8 Rate	1/1 PPG Clock, PPG pattern sync	—
	1/16 Rate	1/1 PPG Clock, PPG pattern sync	—
	1/32 Rate	1/1 PPG Clock, PPG pattern sync	—
	1/64 Rate	1/1 PPG Clock, PPG pattern sync	—
	Bit rates (Option 092 installed)	PPG	ED
	6.25G to 12.5G	1/4 Clock, 1/8 Clock, 1/16 Clock, 1/32 Clock, 1/64 Clock, PPG pattern sync	1/8 Clock, 1/16 Clock
	1/2 Rate	1/2 Clock, 1/4 Clock, 1/16 Clock, PPG pattern sync	1/4 Clock, 1/16 Clock
	1/4 Rate	1/1 Clock, 1/2 PPG Clock, 1/16 PPG Clock, PPG pattern sync	—
	1/8 Rate	1/1 PPG Clock, PPG pattern sync	—
1/16 Rate	1/1 PPG Clock, PPG pattern sync	—	
1/32 Rate	1/1 PPG Clock, PPG pattern sync	—	
1/64 Rate	1/1 PPG Clock, PPG pattern sync	—	
Supported Bit Rates	MP2100B-092 installed	MP2100B-092 not installed	
	Variable bit rate range (1 kbit/s steps) 125 Mbit/s to 12.5 Gbit/s	Variable bit rate range (1 kbit/s steps) 8.5 Gbit/s to 11.32 Gbit/s 1/N Bit rate operation range N = 2: 4.25 Gbit/s to 5.66 Gbit/s N = 4: 2.125 Gbit/s to 2.83 Gbit/s N = 8: 1.0625 Gbit/s to 1.415 Gbit/s N = 16: 531.25 Mbit/s to 707.5 Mbit/s N = 32: 265.625 Mbit/s to 353.75 Mbit/s N = 64: 132.813 Mbit/s to 176.875 Mbit/s	
* 1ch and 3ch bit rate setting synchronized * 2ch and 4ch bit rate setting synchronized			

BERTWave MP2100B Specifications

PPG

Internal Reference Clock Accuracy	Frequency: 10 MHz Internal Reference Clock Accuracy Frequency: ± 10 ppm Offset Variability: ± 100 ppm, 1 ppm step
Data Output	Data, xData Amplitude: Variable 0.1 Vp-p to 0.8 Vp-p, 10 mV steps, AC coupled Amplitude Accuracy: Setting $\pm 20\%$ ± 20 mV Tr/Tf: 24 ps (20 to 80%, typ.), 28 ps (20 to 80%, max.) Jitter (RMS): 1 ps typ. (at 10.3125 Gbit/s, Amplitude 0.4 Vp-p) 2 ps max. (at 10.3125 Gbit/s, Amplitude 0.4 Vp-p) Intrinsic RJ (RMS): 600 fs typ. (at 10.3125 Gbit/s, Amplitude 0.4 Vp-p) 1 ps max. (at 10.3125 Gbit/s, Amplitude 0.4 Vp-p) Skew: ± 15 ps (max.) Connector: SMA, 50 Ω
Test Pattern	PRBS: $2^7 - 1$, $2^9 - 1$, $2^{15} - 1$, $2^{23} - 1$, $2^{31} - 1$ (Inverted On/Off) User data: 1.3 Mbits (text file editing, sample files)
Error Insertion	Repeat, Single Error Rate: $1E-n$ (n: 2 to 12)

ED

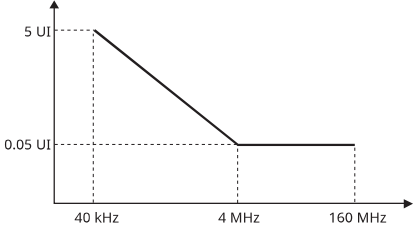
Data Input	<p>Input: Data, xData, Single or Differential switching Input format: NRZ, mark ratio 50%, single end, or differential Threshold value: -0.085 V to $+0.085$ V, 1 mV steps, (at single end termination when external attenuation coefficient is 0 dB) Contiguous same sign tolerance: 72 bit min. (at Bit rate: 9.95328 Gbit/s, Pattern: STM-64 equivalent frame format, mark ratio: 1/2, termination: single end, 20° to 30°C) Lock Range: ± 100 ppm Jitter Tolerance: Bit rate: 10.3125 Gbit/s; PRBS31, single end, Amplitude: 50 mV</p>  <p>External ATT factor: 0 to 30 dB, 1 dB step Connector: SMA, AC coupled* Amplitude: 0.05 Vp-p to 0.8 Vp-p (125 Mbit/s to 12.5 Gbit/s, PRBS31, single end, mark ratio: 1/2, back to back) Sensitivity: 10 mVp-p (typ.), ≤ 20 mVp-p (at 12.5 Gbit/s, PRBS31, single-end, mark ratio 1/2, 20° to 30°C, back to back)</p>
Stressed Eye Sensitivity	BER $1E-12$ at stressed mask specified waveform 10.3125 Gbit/s, single end, JTPAT, mark ratio: 1/2 4.25 Gbit/s, single end, JTPAT, mark ratio: 1/2 2.125 Gbit/s, single end, JTPAT, mark ratio: 1/2

*: The DC component is terminated to GND via a 50 Ω .

BERTWave MP2100B Specifications

Stressed Mask		
	Y1: [mV]	10.3125 Gbps: 25 4.25 Gbps: 25 2.125 Gbps: 25
	X1: [UI]	10.3125 Gbps: 0.325 4.25 GBps: 0.325 2.125 GBps: 0.325
	Total Jitter: TJ [UI]	10.3125 Gbps: 0.65 4.25 Gbps: 0.65 2.125 Gbps: 0.65
	Deterministic Jitter: DJ (d-d) [UI]	10.3125 Gbps: 0.45 4.25 Gbps: 0.45 2.125 Gbps: 0.45
	SJ (p-p) [UI]	10.3125 Gbps: 0.22 4.25 Gbps: 0.22 2.125 Gbps: 0.22
Test Pattern	PRBS: $2^7 - 1$, $2^9 - 1$, $2^{15} - 1$, $2^{23} - 1$, $2^{31} - 1$ (Inversion On/Off) User data: 1.3 Mbits (text file editing, sample files)	
Measurements	Error rate: 0.0001E-18 to 1.0000E-00 Error count: 0 to 9999999, 1.0000E07 to 9.9999E17 Clock recovery: Clock count: 0 to 9999999, 1.0000E07 to 9.9999E17 Frequency: Set bit rate ± 100 ppm Gating time: 1 second to 9 days 23 hours 59 minutes 59 seconds Gating cycle: Single/Repeat/Untimed Auto-sync: On/Off Auto-threshold value: INT/1E-2 to 1E-8 Syn control: Data Frame On/Frame Off setting function (Frame On enabled at pattern lengths of 128 bits or more) Frame length: 64 bit fixed (at Sync control = Frame On) Frame position: 1 to (pattern length - Frame length + 1)/1 bit step (at Sync control = Frame On)	
Alarm Display	Sync loss	

BERTWave MP2100B Specifications

Sampling Oscilloscope

Functions	Waveform Display: Eye pattern, Pulse pattern, Coherent Eye Measurement Functions: Time/Amplitude test, Histogram test, Eye Mask/Mask margin test																	
Sampling Speed	Normal: 100 ksample/s (typ.) Fast Sampling Mode: 150 ksample/s (max.)																	
Horizontal Axis	Clock trigger input Frequency range: 0.1 GHz to 12.5 GHz Input sensitivity: 100 mVp-p (typ.), 200 mVp-p (max.) Absolute max. rating: 2 Vp-p Jitter ≥5 GHz to ≤12.5 GHz: 0.85 ps (typ.), 1.35 ps (max.) ≥1 GHz to <5 GHz: 1.0 ps (typ.), 1.5 ps (max.) ≥0.1 GHz to <1 GHz: 2.0 ps (typ.), 2.5 ps (max.) Display scale: ≥1 UI at full scale (Eye pattern), ≥1 bit at full scale (Pulse pattern) Connector: SMA, 50Ω																	
Vertical Axis (Power Input)	<p>Number of Inputs: 2 (MP2100B-021 installed) Number of Inputs: 1 (MP2100B-023 installed) Bandwidth: (-3 dB): DC to 20 GHz (min.), DC to 25 GHz (typ.) Flatness: ±1 dB (typ.) RMS Noise: 0.5 mV (typ.), 1.75 mV (max.) Absolute max rating: ±2 V Input Range: ±500 mV offset (min.) ±400 mV dynamic range (min.) Connector: K, 50Ω Amplitude accuracy: Measured value ±2% ±Amplitude accuracy</p> <p>Various Amplitude Accuracy Scaled Plotted for Read Value – Offset Value For example, when the offset at a 400 mVp-p signal is 50 mVdc, the + peak side read value is 250 mV and the – peak side read value is –150 mV. When the device scale is set to 50 mV/div and the offset is set to 50 mV, the offset accuracy is found as follows: ±9.5 mV at Peak value +250 mV and +11 mV at Peak value –200 mV. Moreover, since there is a read error of ±2% for the read value, the final error is ±12 mV for Peak value + 200 mV and ±15 mV for Peak value –200 mV.</p>																	
Vertical Axis (Optical Input)	<p>Number of Inputs: 1 (B in) Fiber: 62.5 μm, Multimode or Single mode Wavelength: 750 nm to 1650 nm Bandwidth (-3 dB): DC to 9.0 GHz (typical value with no installed filter options) Optical noise (typ.):</p> <table border="1"> <thead> <tr> <th rowspan="2">Filter Options</th> <th colspan="2">Wavelength (nm)</th> </tr> <tr> <th>1310/1550</th> <th>850</th> </tr> </thead> <tbody> <tr> <td>Option 070 to 075</td> <td>1.8 μW rms</td> <td>3.1 μW rms</td> </tr> <tr> <td>Option 076 to 080</td> <td>1.5 μW rms</td> <td>2.7 μW rms</td> </tr> <tr> <td>Option 081/082</td> <td>2.2 μW rms</td> <td>3.9 μW rms</td> </tr> <tr> <td>Option 086</td> <td>9.9 to ≤10.5G: 1.3 μW rms 10.5 to ≤11.3G: 1.4 μW rms</td> <td>9.9G to 10.5G: 2.4 μW rms 10.5G to 11.3G: 2.5 μW rms</td> </tr> </tbody> </table>	Filter Options	Wavelength (nm)		1310/1550	850	Option 070 to 075	1.8 μW rms	3.1 μW rms	Option 076 to 080	1.5 μW rms	2.7 μW rms	Option 081/082	2.2 μW rms	3.9 μW rms	Option 086	9.9 to ≤10.5G: 1.3 μW rms 10.5 to ≤11.3G: 1.4 μW rms	9.9G to 10.5G: 2.4 μW rms 10.5G to 11.3G: 2.5 μW rms
Filter Options	Wavelength (nm)																	
	1310/1550	850																
Option 070 to 075	1.8 μW rms	3.1 μW rms																
Option 076 to 080	1.5 μW rms	2.7 μW rms																
Option 081/082	2.2 μW rms	3.9 μW rms																
Option 086	9.9 to ≤10.5G: 1.3 μW rms 10.5 to ≤11.3G: 1.4 μW rms	9.9G to 10.5G: 2.4 μW rms 10.5G to 11.3G: 2.5 μW rms																

BERTWave MP2100B Specifications

Optical Data Input (O/E Input)	Input Sensitivity*	
	Filter Options	Uninstalled
		Option 086 installed
		Filter option installed (expect Option 086)
		<p>–15 dBm (typ.)</p> <p>9.9 Gbit/s to 10.5 Gbit/s: –15 dBm (typ.)</p> <p>>10.5 Gbit/s to 11.3 Gbit/s: –14.4 dBm (typ.)</p> <p>–12 dBm (typ.)</p>
	<p>* Input sensitivity is Eye Mask test range.</p> <p>Max. input power: –1 dBm or 794 μW (average power)</p> <p>+2 dBm or 1.58 mW (peak power)</p> <p>Absolute max. rating: +5 dBm or 3.16 mW (peak power)</p> <p>Optical Power Measurement</p> <p>Measurement Range: –18 to 0 dBm</p> <p>Measurement Accuracy: \pm0.35 dB (–12 dBm min., typ.)</p> <p>\pm0.6 dB (<–12 dBm, typ.)</p> <p>Optical Return Loss: –30 dB (typ.)</p> <p>Connector: Select one of following options:</p> <p>Option 037 FC Connector</p> <p>Option 040 SC Connector</p>	
Low Pass Filter (156M) (Option 070)	0.116 GHz (–3 dB typ. cutoff frequency) LPF	Application: OC-3/STM-1 (155.52 Mbit/s)
Low Pass Filter (622M) (Option 071)	0.47 GHz (–3 dB typ. cutoff frequency) LPF	Application: OC-12/STM-4 (622.08 Mbit/s), CPRI (614.4 Mbit/s)
Low Pass Filter (1.0G) (Option 072)	0.80 GHz (–3 dB typ. cutoff frequency) LPF	Application: 1 GFC (1.0625 Gbit/s)
Low Pass Filter (1.2G) (Option 073)	0.94 GHz (–3 dB typ. cutoff frequency) LPF	Application: 1 GbE (1.25G), OC-24 (1.244G), CPRI \times 2 (1.2288 G)
Low Pass Filter (2.5G) (Option 075)	1.87 GHz (–3 dB typ. cutoff frequency) LPF	Application: CPRI \times 4 (2.4576 G), OC-48/STM-16 (2.488G), 2 GbE (2.5G), InfiniBand Optical (2.5G)
Low Pass Filter (2.1G) (Option 076)	1.6 GHz (–3 dB typ. cutoff frequency) LPF	Application: 2GFC (2.125 Gbit/s)
Low Pass Filter (2.6G) (Option 078)	2.0 GHz (–3 dB typ. cutoff frequency) LPF	Application: OTU-1 (2.66648 Gbit/s)
Low Pass Filter (3.1G) (Option 079)	2.37 GHz (–3 dB typ. cutoff frequency) LPF	Application: CPRI \times 5 (3.072 Gbit/s), 10GBASE-LX4 (3.125 Gbit/s), 10GFC-LX4 (3.1875 Gbit/s)
Low Pass Filter (4.2G) (Option 080)	3.2 GHz (–3 dB typ. cutoff frequency) LPF	Application: 4GFC (4.25 Gbit/s)
Low Pass Filter (5.0G) (Option 081)	3.75 GHz (–3 dB typ. cutoff frequency) LPF	Application: InfiniBand Optical \times 2 (5 Gbit/s), CPRI \times 8 (4.9515 Gbit/s)
Low Pass Filter (6.2G) (Option 082)	4.61 GHz (–3 dB typ. cutoff frequency) LPF	Application: CPRI \times 10 (6.144 Gbit/s), XAUI Optical \times 2 (6.25 Gbit/s)
Low Pass Filter (8.5G to 11.3G) (Option 086)	7.5 GHz (–3 dB typ. cutoff frequency) LPF	Application: 8GFC (8.5 Gbit/s), 10 GbE WAN (9.95328 Gbit/s), 10 GbE LAN/PHY (10.3125 Gbit/s), OC-192/STM-64 (9.95328 Gbit/s), InfiniBand Optical \times 4 (10 Gbit/s), 10GFC (10.51875 Gbit/s), G975 FEC (10.664228 Gbit/s), OTU-2 (10.709225 Gbit/s), 10 GbE FEC (11.095728 Gbit/s), 10GFC FEC (11.3168 Gbit/s)

BERTWave MP2100B Specifications

Clock Recovery

CRU Input (Option 053)	Connector: SMA jack, 50Ω, AC coupled* Input sensitivity: 100 mVp-p (typ.) Max. amplitude: 2 Vp-p (input before damage)
CRU Input (Option 054)	Connector: FC or SC Input sensitivity: -9 dBm (typ., using Option 070 to 082) -12 dBm (typ., using Option 086, 9.9 to 10.5G) -11.4 dBm (typ., using Option 086, >10.5G) Max. input power: -1 dBm or 794 μW (avg.) +2 dBm or 1.58 mW (peak) Max. rating: +5 dBm or 3.16 mW (peak)
CRU Input (Option 055)	Connector: SMA jack, 50Ω, AC coupled* Input sensitivity: 0.05 Vp-p to 0.8 Vp-p * Same to ED 1 Data In
CRU Output	Connector: SMA jack, 50Ω, AC coupled Amplitude: 0.27 Vp-p to 0.54 Vp-p (≤2.7 GHz), 0.5 Vp-p to 1.5 Vp-p (8.5 GHz to 12.5 GHz)
Clock Rate	8.5 GHz to 12.5 GHz, 0.1 GHz to 2.7 GHz
Jitter, RMS (Summed)	8.5 GHz to 12.5 GHz band: 10 mUI (typ.), 20 mUI (max., 4 MHz loop BW) 0.1 GHz to 2.7 GHz band: 5 mUI (max.)
Loop Band (typ.)	8.5 GHz to 12.5 GHz band: 1, 2, 4, 8 MHz (typ., switchable) 0.1 GHz to 2.7 GHz band 2488.32 MHz: 200 kHz (typ.) 622 MHz: 50 kHz (typ.) 156 MHz: 20 kHz (typ.)

*: The DC component is terminated to GND via a 50Ω.

SFP+ Slot (Option 051)

Tx Data Input	Data Input Level (single end): 0.6 Vp-p to 0.8 Vp-p (with G0238) 0.25 Vp-p to 0.35 Vp-p (with G0239A) Input waveform: NRZ Connector: SMA, 50Ω/GND
Rx Data Output	Data output level (single end): 0.10 Vp-p (min.), 1.0 Vp-p (max.) Output waveform: NRZ Connector: SMA, 50Ω/GND
Laser Safety Standard	CLASS 1 (IEC60825-1, 21) CLASS I (FDA 21CFR1040.10)

BERTWave MP2100B Ordering Information

Please specify the model/order number, name and quantity when ordering.
The names listed in the chart below are Order Names. The actual name of the item may differ from the Order Name.

Model/Order No.	Name
MP2100B	Main Frame BERTWave
	Standard Accessories
	Power Cord: 1
	BERTWave Control Software (CD-ROM, Operation manual): 1
	Options
MP2100B-011	1CH BERT
MP2100B-012	2CH BERT
MP2100B-014	4CH BERT
MP2100B-021	Dual Electrical Scope
MP2100B-023	Optical and Single-ended Electrical Scope
MP2100B-030	GPIB
MP2100B-037	FC Connector
MP2100B-040	SC Connector
MP2100B-051	SFP+ Slot
MP2100B-053	Clock Recovery (External Input)
MP2100B-054	Clock Recovery (Optical Data)
MP2100B-055	Clock Recovery (with BER Measurement)
MP2100B-063	High Rate Filter Bank
MP2100B-065	Low Rate Filter Bank
MP2100B-069	Multi Rate Filter Bank
MP2100B-070	LPF for 156M (L)
MP2100B-071	LPF for 622M (L)
MP2100B-072	LPF for 1.0G (L)
MP2100B-073	LPF for 1.2G (L)
MP2100B-075	LPF for 2.5G (L)
MP2100B-076	LPF for 2.1G (H)
MP2100B-078	LPF for 2.6G (H)
MP2100B-079	LPF for 3.1G (H)
MP2100B-080	LPF for 4.2G (H)
MP2100B-081	LPF for 5.0G (H)
MP2100B-082	LPF for 6.2G (H)
MP2100B-086	LPF for Multi 10G (8.5G to 11.3G) (H)
MP2100B-087	Filter Bank Set (622M/1.2G/2.5G/4.2G/6.2G/Multi 10G)
MP2100B-088	Filter Bank Set (4.2G/5.0G/6.2G/ Multi 10G)
MP2100B-089	Filter Bank Set (156M/622M/1.2G/2.5G)
MP2100B-092	PPG/ED Bit Rate Extension for 125M to 12.5G

Model/Order No.	Name
	Retrofit Options*
MP2100B-111	1CH BERT Retrofit
MP2100B-112	2CH BERT Retrofit
MP2100B-114	4CH BERT Retrofit
MP2100B-121	Dual Electrical Scope Retrofit
MP2100B-123	Optical and Single-ended Electrical Scope Retrofit
MP2100B-130	GPIB Retrofit
MP2100B-151	SFP+ Slot Retrofit
MP2100B-153	Clock Recovery (External Input) Retrofit
MP2100B-154	Clock Recovery (Optical Data) Retrofit
MP2100B-155	Clock Recovery (with BER Measurement) Retrofit
MP2100B-176	LPF for 2.1G (H) Retrofit
MP2100B-178	LPF for 2.6G (H) Retrofit
MP2100B-179	LPF for 3.1G (H) Retrofit
MP2100B-180	LPF for 4.2G (H) Retrofit
MP2100B-181	LPF for 5.0G (H) Retrofit
MP2100B-182	LPF for 6.2G (H) Retrofit
MP2100B-186	LPF for Multi 10G (8.5G to 11.3G) (H) Retrofit
MP2100B-187	Filter Bank Set (622M/1.2G/2.5G/4.2G/6.2G/Multi 10G) Retrofit
MP2100B-188	Filter Bank Set (4.2G/5.0G/6.2G/ Multi 10G) Retrofit
MP2100B-189	Filter Bank Set (156M/622M/1.2G/2.5G) Retrofit
MP2100B-192	PPG/ED Bit Rate Extension for 125M to 12.5G Retrofit
	Standard Accessories (MP2100B-x11)
	Terminator: 2
	Open (Coaxial connector cover): 5
	Standard Accessories (MP2100B-x12)
	Terminator: 4
	Open (Coaxial connector cover): 7
	Standard Accessories (MP2100B-x14)
	Terminator: 8
	Open (Coaxial connector cover): 11
	Standard Accessories (MP2100B-x21)
	Open (Coaxial connector cover): 3
	Coaxial Adaptor (K-P · K-J, SMA compatible): 2
	Standard Accessories (MP2100B-x23)
	Open (Coaxial connector cover): 2
	Coaxial Adaptor (K-P · K-J, SMA compatible): 1
	Standard Accessories (MP2100B-x51)
	Open (Coaxial connector cover): 2
	Standard Accessories (MP2100B-x53)
	Open (Coaxial connector cover): 2
	Standard Accessories (MP2100B-x54)
	Open (Coaxial connector cover): 1
	Standard Accessories (MP2100B-x55)
	Open (Coaxial connector cover): 1
	Maintenance Service
MP2100B-ES310	3 Years Extended Warranty Service
MP2100B-ES510	5 Years Extended Warranty Service

*: Retrofit options

- BERT retrofits (Option 111/112/114) are supported when no BERT is built-in.
- Scope retrofits (Option 121/123) are supported when no Scope is built-in.
- Scope retrofit Option 123 does not support separate filter retrofits (Option 176/178/179/180/181/182/186). Only filter bank and filter set retrofit Option 187/188/189 are supported.
- Retrofit of low-bit-rate filters (L) is not supported.

BERTWave MP2100B Ordering Information

Model/Order No.	Name
	Optional Accessories
J1137	Terminator
J1341A	Open (Coaxial connector cover)
J1359A	Coaxial Adaptor (K-P · K-J, SMA compatible)
J1349A	Coaxial Cable 0.3 m
J1342A	Coaxial Cable 0.8 m
J1625A	Coaxial Cable 1 m (SMA connector)
G0238A	SFP+ SR 850 nm
G0239A	SFP+ LR 1310 nm
G0177A	850 nm SFP module (1.062 to 4.25 Gbit/s)
G0178A	1310 nm SFP Module (0.155 to 2.67 Gbit/s)
G0179A	1550 nm SFP Module (0.155 to 2.67 Gbit/s)
J1344A	LC/PC-LC/PC-1M-SM
J1139A	FC · PC-LC · PC-1M-SM
J1345A	SC/PC-LC/PC-1M-SM
J1346A	LC/PC-LC/PC-1M-GI (62.5/125)
J1347A	FC/PC-LC/PC-1M-GI (62.5/125)
J1348A	SC/PC-LC/PC-1M-GI (62.5/125)
J1510A	Pick OFF Tee
J0617B	Replaceable Optical Connector (FC-PC)
J0618D	Replaceable Optical Connector (ST)
J0618E	Replaceable Optical Connector (DIN)
J0619B	Replaceable Optical Connector (SC)
B0716A	Carrying Case
J1512A	7.5 GHz Passive Probe Set
B0650A	Rack Mount Kit
J1519A	Optical Fiber Cord (MM, 12FIBER, MPO,3M)
J1680A	4Channel CWDM MUX or DEMUX
J1681A	MPO Loopback Cable
J1682A	MPO to FC convert cable
G0334A	40G LR4 1310 nm QSFP+
G0359A	40G SR4 850 nm QSFP+
W3772AE	MP2100B BERTWave Operation Manual
W3773AE	BERTWave Series Remote Control Operation Manual
Z0306A	Wrist Strap
J1627A	GND connection cable
G0342A	ESD Discharger
Z0914A	Ferrule Cleaner
Z0915A	Replacement Reel for Ferrule Cleaner
	Software
MX210001A	Jitter Analysis Software
MX210002A	Transmission Analysis Software

BERTWave MP2100B Related Products

Optical Spectrum Analyzer MS9740B

600 nm to 1750 nm

Faster measurement speed shortens measurement time and improves production efficiency

- Faster measurement speed of <0.2 s/5 nm reduces total analysis time for active optical devices
- Built-in applications for evaluating active optical devices
- Built-in Fast mode cuts measurement time by 50% for better production efficiency to predecessor MS9740A using 200 Hz or 1 kHz bandwidth
- Excellent cost performance
- >58 dB dynamic range (0.4 nm from peak wavelength)
- 30 pm minimum resolution
- Low power consumption (75 VA), light weight (15 kg max.)

The MS9740B reduces production costs by shortening active optical device evaluation times and supporting efficient analysis applications.



BERTWave™ MP2110A

For 100G/200G/400G Multi-channel Optical Module/Device R&D and Manufacturing

- All-in-one max. 4ch 28.2 Gbit/s BERT + max. 4ch sampling oscilloscope
- Supports analysis of both NRZ and PAM4 signals with high-speed, low-noise sampling oscilloscope, and built-in CRU.

With a built-in BERT (for Bit Error Rate measurements) and a sampling oscilloscope (for Eye pattern analysis) the All-in-one MP2110A is optimized for manufacturing 100G/200G/400G optical modules. The MP2110A will improve optical module production efficiency and reduce manufacturing costs.



Optical Attenuator G035xF/S

This bench-top optical attenuator has an optical attenuation of 60 dB. Support for remote control over GPIB makes it easy to configure a remote measurement setup in combination with the the BERTWave series.

Choose the model with the correct fiber connectors for the application.



Optical Switch G034xF/S

This bench-top optical switch supports 1×4, 2×4, and 1×16 switching. Support for remote control over GPIB makes it easy to configure a remote measurement setup in combination with the the BERTWave series.

Choose the model with the correct fiber connectors for the application.



Model/Order No.	Name
G0350F*	Programmable Optical Attenuator (SM9, FC/UPC)
G0350S*	Programmable Optical Attenuator (SM9, SC/UPC)
G0351F*	Programmable Optical Attenuator (SM9, FC/UPC, Power Monitor)
G0351S*	Programmable Optical Attenuator (SM9, SC/UPC, Power Monitor)
G0352F*	Programmable Optical Attenuator (GI50, FC/UPC)
G0352S*	Programmable Optical Attenuator (GI50, SC/UPC)
G0353F*	Programmable Optical Attenuator (GI50, FC/UPC, Power Monitor)
G0353S*	Programmable Optical Attenuator (GI50, SC/UPC, Power Monitor)
G0354F*	Programmable Optical Attenuator (GI62.5, FC/UPC)
G0354S*	Programmable Optical Attenuator (GI62.5, SC/UPC)
G0355F*	Programmable Optical Attenuator (GI62.5, FC/UPC, Power Monitor)
G0355S*	Programmable Optical Attenuator (GI62.5, SC/UPC, Power Monitor)

Model/Order No.	Name
G0344F*	Optical Switch (1×4, SM9, FC/UPC)
G0344S*	Optical Switch (1×4, SM9, SC/UPC)
G0345F*	Optical Switch (1×16, SM9, FC/UPC)
G0345S*	Optical Switch (1×16, SM9, SC/UPC)
G0346F*	Optical Switch (1×4, GI50, FC/UPC)
G0346S*	Optical Switch (1×4, GI50, SC/UPC)
G0347F*	Optical Switch (1×4, GI62.5, FC/UPC)
G0347S*	Optical Switch (1×4, GI62.5, SC/UPC)
G0348F*	Optical Switch (2×4, GI50, FC/UPC)
G0348S*	Optical Switch (2×4, GI50, SC/UPC)
G0349F*	Optical Switch (2×4, GI62.5, FC/UPC)
G0349S*	Optical Switch (2×4, GI62.5, SC/UPC)

*: KC Mark not support

*: KC Mark not support

Note

● **United States**

Anritsu Americas Sales Company

450 Century Parkway, Suite 190, Allen,
TX 75013, U.S.A.
Phone: +1-800-Anritsu (1-800-267-4878)

● **Canada**

Anritsu Electronics Ltd.

700 Silver Seven Road, Suite 120, Kanata,
Ontario K2V 1C3, Canada
Phone: +1-613-591-2003
Fax: +1-613-591-1006

● **Brazil**

Anritsu Eletronica Ltda.

Praça Amadeu Amaral, 27 - 1 Andar
01327-010 - Bela Vista - Sao Paulo - SP
Brazil
Phone: +55-11-3283-2511
Fax: +55-11-3288-6940

● **Mexico**

Anritsu Company, S.A. de C.V.

Bldv Miguel de Cervantes Saavedra #169 Piso 1, Col. Granada
Mexico, Ciudad de Mexico, 11520, MEXICO
Phone: +52-55-4169-7104

● **United Kingdom**

Anritsu EMEA Ltd.

200 Capability Green, Luton, Bedfordshire, LU1 3LU, U.K.
Phone: +44-1582-433200
Fax: +44-1582-731303

● **France**

Anritsu S.A.

12 avenue du Québec, Bâtiment Iris 1- Silic 612,
91140 VILLEBON SUR YVETTE, France
Phone: +33-1-60-92-15-50
Fax: +33-1-64-46-10-65

● **Germany**

Anritsu GmbH

Nemetschek Haus, Konrad-Zuse-Platz 1
81829 München, Germany
Phone: +49-89-442308-0
Fax: +49-89-442308-55

● **Italy**

Anritsu S.r.l.

Via Elio Vittorini 129, 00144 Roma, Italy
Phone: +39-6-509-9711
Fax: +39-6-502-2425

● **Sweden**

Anritsu AB

Isafjordsgatan 32C, 164 40 KISTA, Sweden
Phone: +46-8-534-707-00

● **Finland**

Anritsu AB

Teknobulevardi 3-5, FI-01530 VANTAA, Finland
Phone: +358-20-741-8100
Fax: +358-20-741-8111

● **Denmark**

Anritsu A/S

Torveporten 2, 2500 Valby, Denmark
Phone: +45-7211-2200
Fax: +45-7211-2210

● **Russia**

Anritsu EMEA Ltd.

Representation Office in Russia

Tverskaya str. 16/2, bld. 1, 7th floor.
Moscow, 125009, Russia
Phone: +7-495-363-1694
Fax: +7-495-935-8962

● **Spain**

Anritsu EMEA Ltd.

Representation Office in Spain

Edificio Cuzco IV, Po. de la Castellana, 141, Pta. 5
28046, Madrid, Spain
Phone: +34-915-726-761
Fax: +34-915-726-621

● **United Arab Emirates**

Anritsu EMEA Ltd.

Dubai Liaison Office

902, Aurora Tower,
P O Box: 500311- Dubai Internet City
Dubai, United Arab Emirates
Phone: +971-4-3758479
Fax: +971-4-4249036

● **India**

Anritsu India Private Limited

6th Floor, Indiqube ETA, No.38/4, Adjacent to EMC2,
Doddanekundi, Outer Ring Road, Bengaluru - 560048, India
Phone: +91-80-6728-1300
Fax: +91-80-6728-1301

● **Singapore**

Anritsu Pte. Ltd.

11 Chang Charn Road, #04-01, Shriro House
Singapore 159640
Phone: +65-6282-2400
Fax: +65-6282-2533

● **P.R. China (Shanghai)**

Anritsu (China) Co., Ltd.

Room 2701-2705, Tower A,
New Caohejing International Business Center
No. 391 Gui Ping Road Shanghai, 200233, P.R. China
Phone: +86-21-6237-0898
Fax: +86-21-6237-0899

● **P.R. China (Hong Kong)**

Anritsu Company Ltd.

Unit 1006-7, 10/F., Greenfield Tower, Concordia Plaza,
No. 1 Science Museum Road, Tsim Sha Tsui East,
Kowloon, Hong Kong, P.R. China
Phone: +852-2301-4980
Fax: +852-2301-3545

● **Japan**

Anritsu Corporation

8-5, Tamura-cho, Atsugi-shi, Kanagawa, 243-0016 Japan
Phone: +81-46-296-6509
Fax: +81-46-225-8352

● **Korea**

Anritsu Corporation, Ltd.

5FL, 235 Pangyoeyeok-ro, Bundang-gu, Seongnam-si,
Gyeonggi-do, 13494 Korea
Phone: +82-31-696-7750
Fax: +82-31-696-7751

● **Australia**

Anritsu Pty. Ltd.

Unit 20, 21-35 Ricketts Road,
Mount Waverley, Victoria 3149, Australia
Phone: +61-3-9558-8177
Fax: +61-3-9558-8255

● **Taiwan**

Anritsu Company Inc.

7F, No. 316, Sec. 1, NeiHu Rd., Taipei 114, Taiwan
Phone: +886-2-8751-1816
Fax: +886-2-8751-1817